



RT 130

**130 USt Lifting Capacity
Rough Terrain Crane
Datasheet
Imperial**



RT 130

Features:

- ▶ Rated capacity:
130 USt @ 10 ft working radius
- ▶ Maximum boom length:
155 ft
- ▶ Maximum tip height:
164 ft

WORKS FOR YOU.™

Key

.....	3
-------	---

Dimensions

Crane dimensions	4
Crane weights	5
Steering Radii – Two Wheel Steer	6
Steering Radii – Four Wheel Steer	7

Load charts

Range Diagram – Main Boom – Outriggers fully extended (100%) Dual Mode	8
Load Chart – Main Boom – Outriggers fully extended (100%) Dual Mode	9
Range Diagram – Main Boom – Outriggers half extended (50%) Dual Mode	10
Load Chart – Main Boom – Outriggers half extended (50%) Dual Mode	11
Range Diagram – Main Boom – 28.8 ft offsettable jib	12
Load Chart – Main Boom – 28.8 ft offsettable jib	13
Range Diagram – Main Boom – 54.9 ft offsettable jib	14
Load Chart – Main Boom – 54.9 ft offsettable jib	15
Range Diagram – Main Boom – 72.1 ft offsettable jib	16
Load Chart – Main Boom – 72.1 ft offsettable jib	17
Range Diagram – Main Boom – On tires	18
Load Chart – Main Boom – On tires	19
Range Diagram – Main Boom – Without counterweight	20
Load Chart – Main Boom – Without counterweight	21

Technical description

Boom	22
Hoist, rope and hook	22, 23
Superstructure	23
Cab, controls, operator aids and load limiter / load indicator	24
Carrier, engine, drive-line and hydraulic system	24, 25
Vehicle performance	25
Tires	25
Other options	25

	Counterweight		General performance
	Main boom		Telescoping mode
	Boom length		Working radius
	Tip height		Max. boom length with extension
	Boom with extension		Distance from the hook to the head sheave pin
	Main boom with aux head		Hook ball
	Slewing / Allowable slewing range		Slewing locked / Slewing locked at specified position
	Slewing brake		Slewing gears
	Outriggers / Lifting on outriggers (100/50/0% extended)		Lifting on wheels / Pick & Carry
	Main hoist		Auxiliary hoist
	Hoist speed		Rope length
	Rope - Standard / Optional		Max. line pull
	Rope diameter		Tire
	Hook block		Controls
	Cab		Engine
	Operator aids / Load limiter / Load indicator		Steering
	Mechanical transmission		Speed
	HYDR Hydraulics		Heating / Air conditioning
	Working temperature		Gradeability
	Lights		Gross vehicle weight
	Crane / Crane in standard configuration		Weight on front axle
	Crane without counterweight		Weight on rear axle

CRANE DIMENSIONS



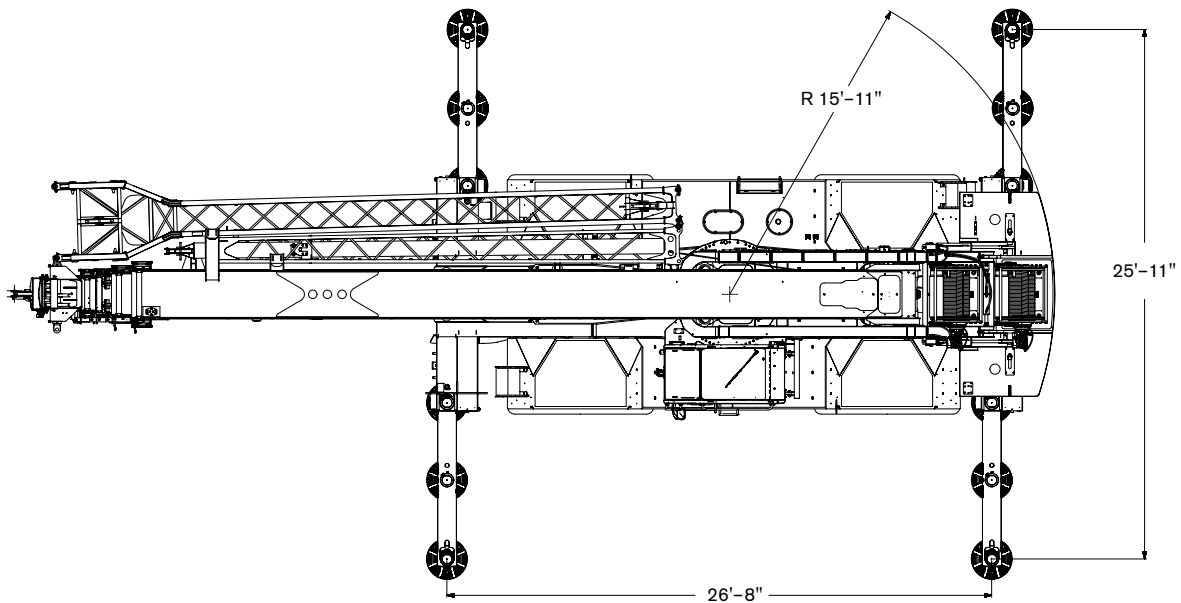
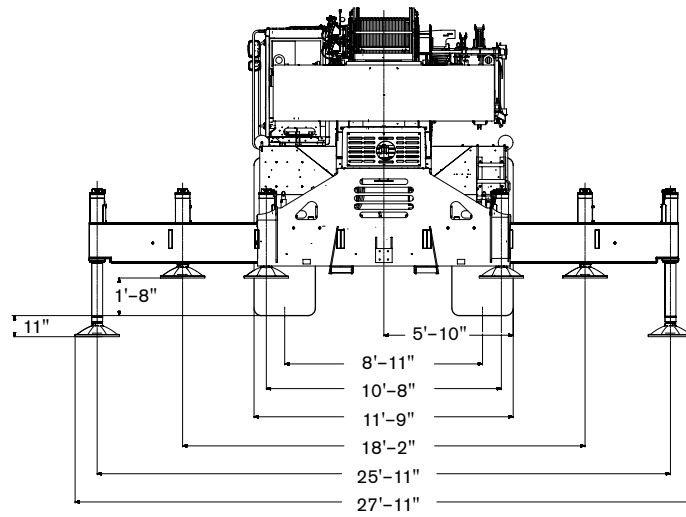
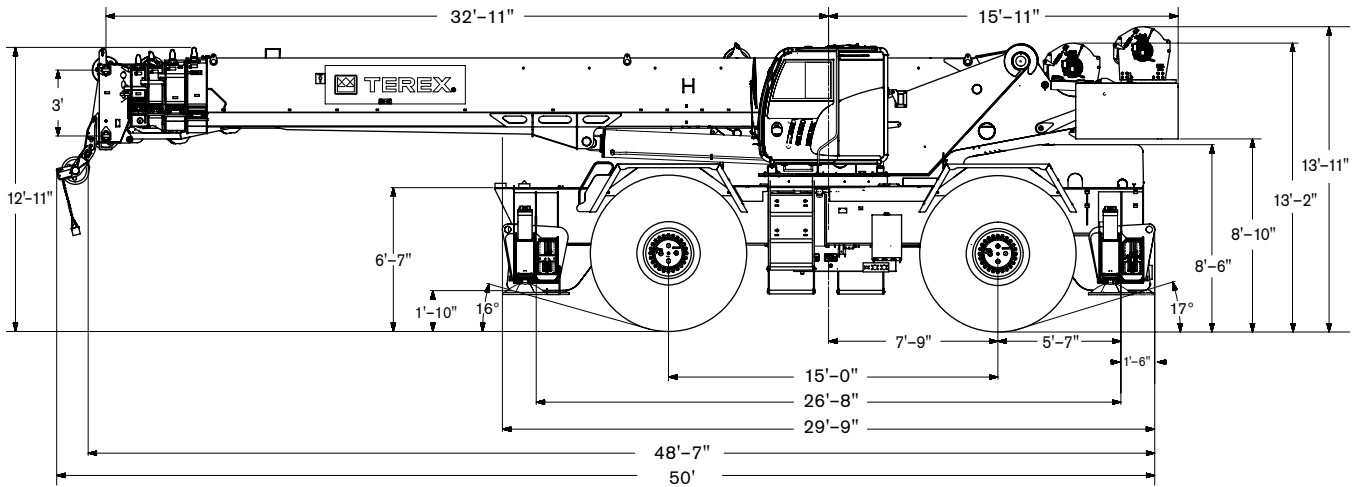





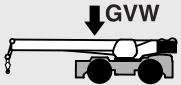
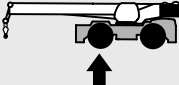
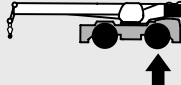
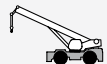
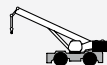

RT 130



CRANE WEIGHTS

RT 130

Approximate Weights

				
	Without counterweights	108,052 lb	75,589 lb	32,463 lb
	In standard configuration	134,212 lb	57,911 lb	76,301 lb
Add / Subtract for main crane configuration				
	Stowed aside the boom	+ 3,560 lb	+ 5,790 lb	- 2,230 lb
	Auxiliary boom head	+ 208 lb	+ 575 lb	- 367 lb
	Optional	+ 221 lb	- 50 lb	+ 271 lb
	With standard rope	+ 659 lb	- 253 lb	+ 912 lb
	With optional rope	+ 880 lb	- 350 lb	+ 1,230 lb
	7 sheaves, 130 USt hanging down from boom head	+ 2,310 lb	+ 3,889 lb	- 1,579 lb
	7 sheaves, 100 USt hanging down from boom head	+ 2,120 lb	+ 3,569 lb	- 1,449 lb
	5 sheaves, 75 USt hanging down from boom head	+ 1,568 lb	+ 2,639 lb	- 1,071 lb
	Hook ball, 12 USt (in tool box)	+ 722 lb	+ 763 lb	- 41 lb

NOTE: Values are subject to 2% variation

For complete list of adds and subtracts refer to user manual.

STEERING RADII

RT130

Two Wheel Steer

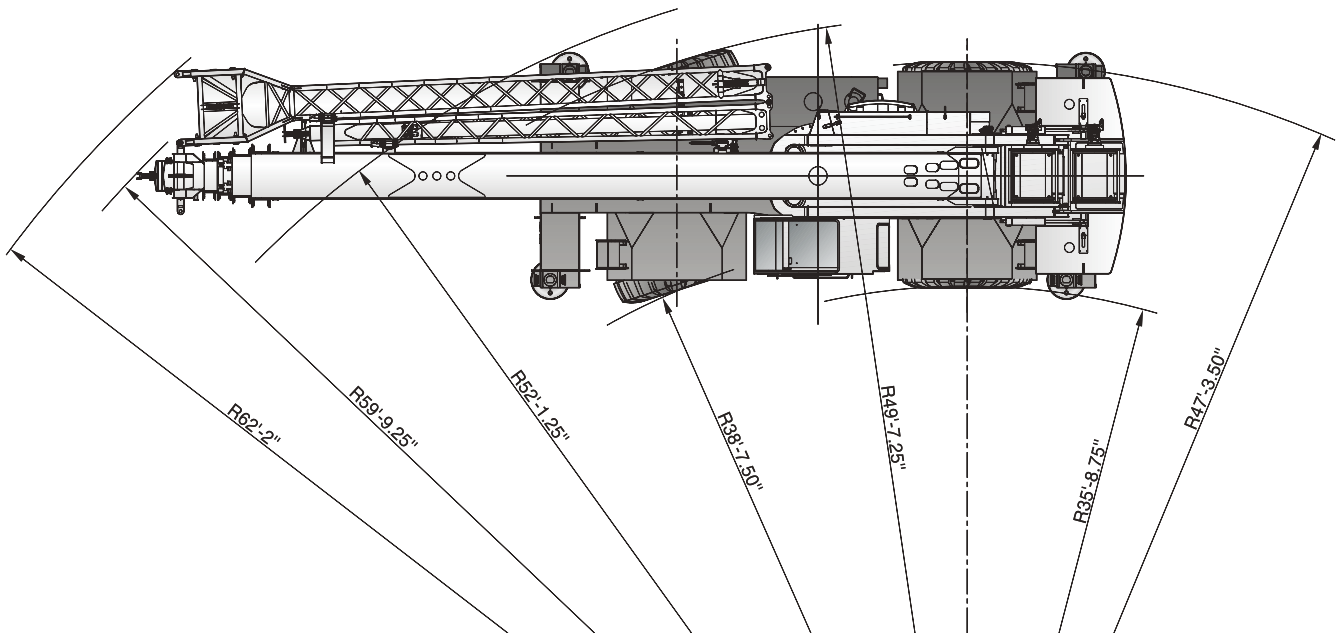

STEERING RADII

RT 130

Four Wheel Steer

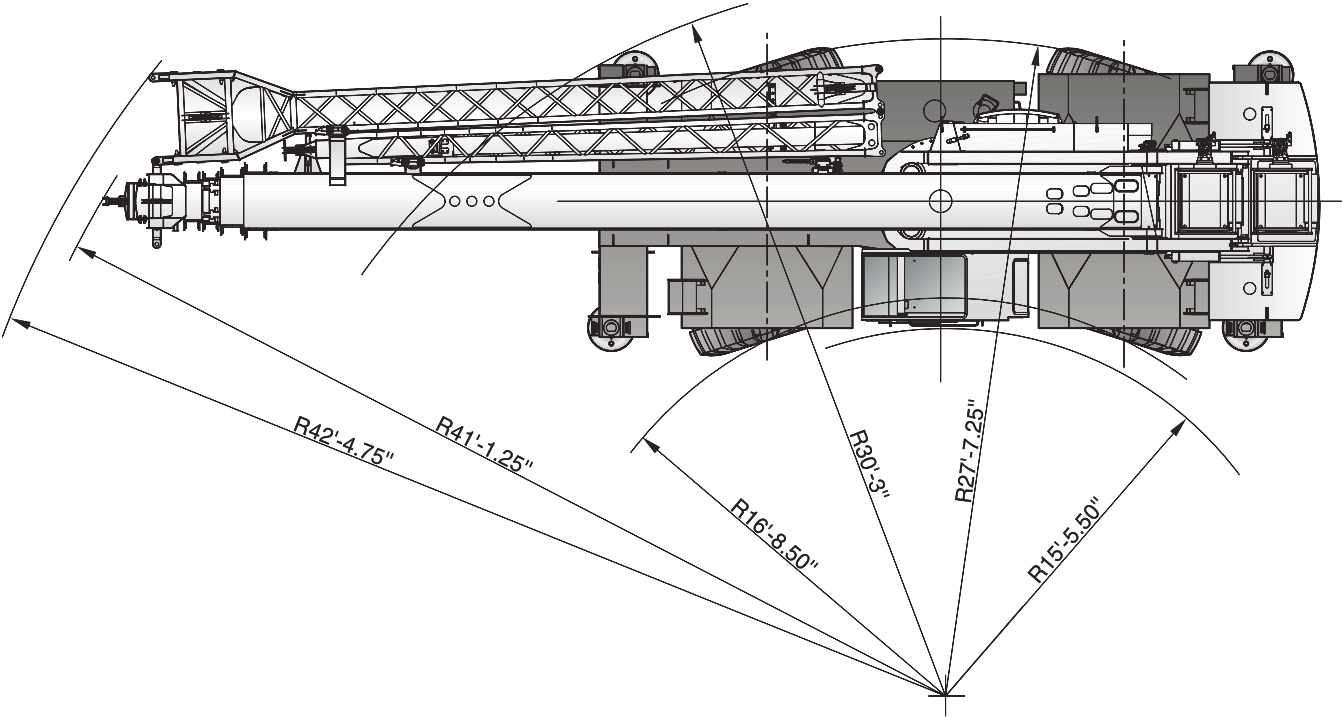

RANGE DIAGRAM - MAIN BOOM

RT 130

Outriggers Fully Extended (100%), Dual Mode

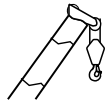

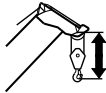
 with hook ball: 7.5 ft
with hook block: 10 ft

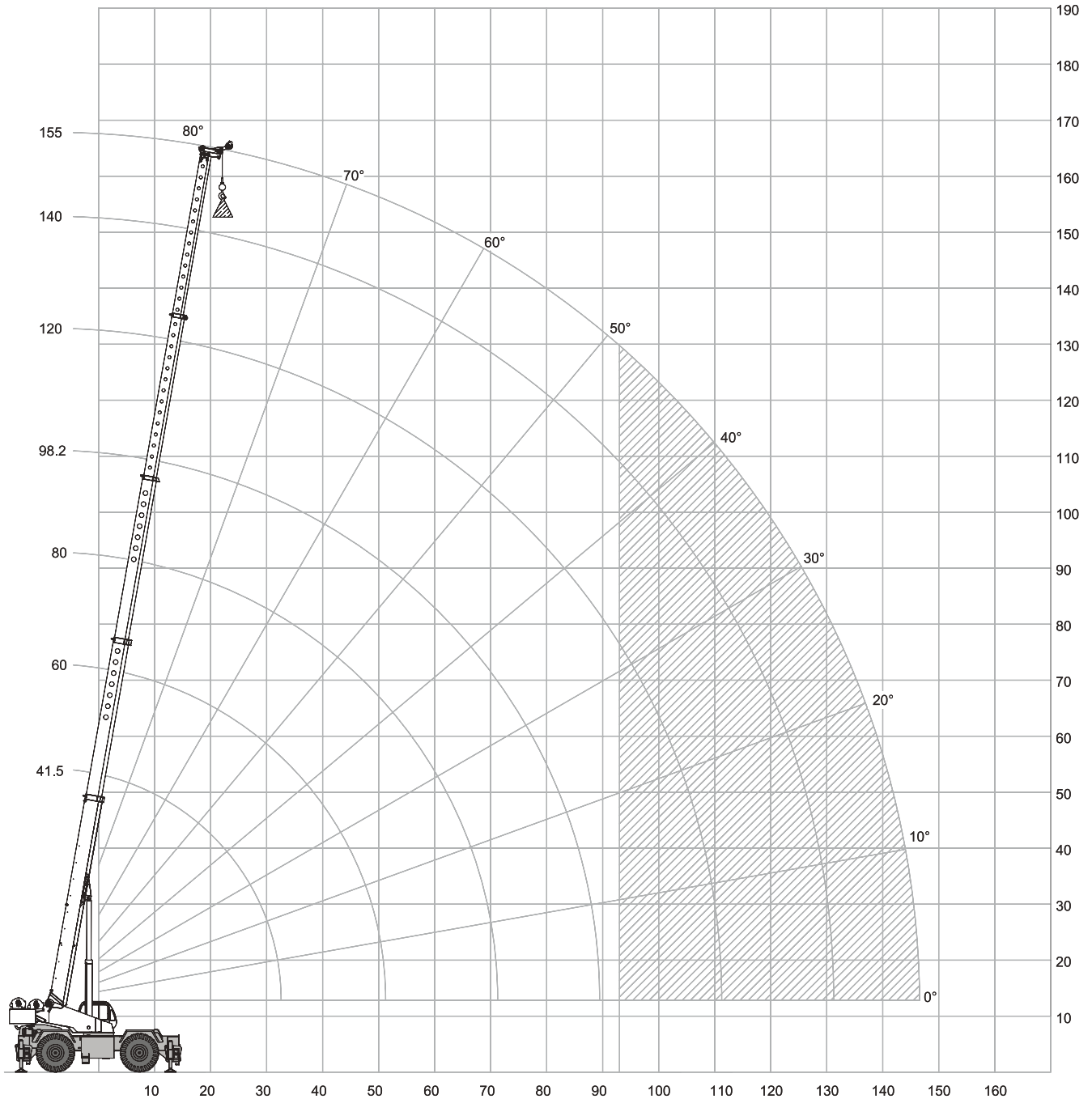



LOAD CHART- MAIN BOOM

RT 130

Outriggers Fully Extended (100%), Dual Mode

 29,600 lbs counterweight

 Outriggers extended 26 ft (100%)

 360 degree rotation

Standard ASME B30.5

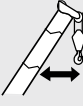
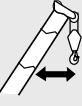
	Boom Length							
	41.5 ft	60 ft	80 ft	100 ft	120 ft	140 ft	155 ft	
ft	lb	lb	lb	lb	lb	lb	lb	ft
10	260,000							10
12	199,700	150,000						12
15	169,500	150,000	107,200					15
20	131,900	130,200	105,500	85,000				20
25	105,900	104,300	88,000	71,400	60,900			25
30	86,800	89,500	75,100	60,900	52,700	42,800		30
35		66,600	65,200	53,100	45,800	39,400	30,000	35
40		57,700	50,700	46,600	40,600	35,600	26,800	40
45		46,500	41,300	41,700	36,000	31,800	25,200	45
50		37,900	33,500	36,000	32,200	28,800	23,600	50
55			29,900	30,000	29,000	26,000	22,000	55
60			27,800	25,200	26,600	23,500	20,400	60
65			25,200	21,400	22,900	21,300	18,700	65
70			21,600	18,400	19,700	19,400	17,200	70
75				17,000	17,000	17,700	15,900	75
80				15,800	14,700	15,700	14,700	80
85				14,700	12,700	13,800	13,800	85
90				13,800	11,200	12,000	12,600	90
95					10,500	10,800	11,100	95
100					9,800	10,100	9,800	100
105					9,200	9,500	8,600	105
110					8,400	8,600	7,500	110
115						7,600	6,500	115
120						6,600	5,600	120
125						5,700	4,800	125
130						4,900	4,000	130
135							3,300	135
140							2,600	140
145							2,000	145

Mode 1 Optimized for best capacities on longer radius

Mode 2 Optimized for best capacities on short radius

Notes to lifting capacity

Lifting capacities do not exceed 85% of tipping load. Weight of hook blocks and slings is part of the load, and is to be deducted from the capacity ratings. Consult operation manual for further details.

Note: Data published herein is intended as a guide only and shall not be construed to warrant applicability for lifting purposes. Crane operation is subject to the computer charts and operation manual both supplied with the crane.

RANGE DIAGRAM - MAIN BOOM

RT 130

Outriggers Half Extended (50%), Dual Mode

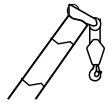

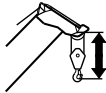
 with hook ball: 7.5 ft
with hook block: 10 ft

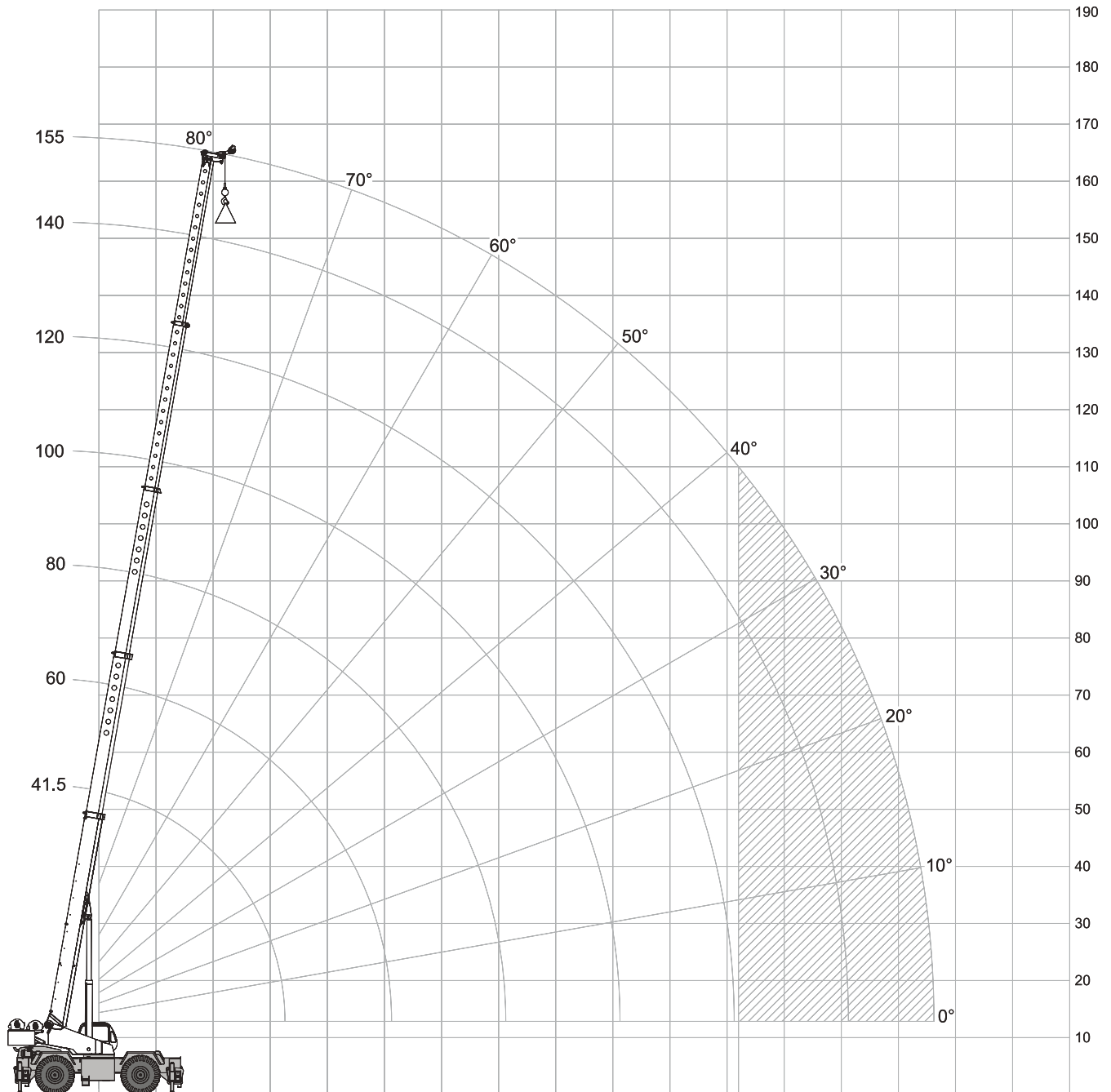



LOAD CHART- MAIN BOOM

RT 130

Outriggers Half Extended (50%), Dual Mode

 29,600 lbs counterweight

 Outriggers extended 18.1 ft (50%)

 360 degree rotation

Standard ASME B30.5

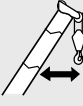
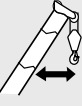
	Boom Length							
	41.5 ft	60 ft	80 ft	100 ft	120 ft	140 ft	155 ft	
ft	lb	lb	lb	lb	lb	lb	lb	ft
10	212,700							10
12	186,000	150,000						12
15	155,100	150,000	107,200					15
20	108,100	103,800	105,100	85,000				20
25	69,600	73,600	67,200	70,200	60,900			25
30	48,600	53,100	51,600	49,900	51,700	42,800		30
35		40,500	42,300	37,500	39,100	39,400	30,000	35
40		31,800	33,700	31,900	30,600	31,800	26,800	40
45		25,300	27,500	28,500	24,500	25,600	25,200	45
50		20,200	22,800	23,800	21,500	22,000	21,900	50
55			19,000	20,100	19,400	19,600	18,300	55
60			15,800	17,100	16,800	16,600	15,300	60
65			13,200	14,600	14,300	14,200	12,900	65
70			11,000	12,500	12,300	12,100	10,900	70
75				10,700	10,500	10,400	9,200	75
80				9,100	9,000	8,900	7,700	80
85				7,600	7,700	7,600	6,400	85
90				6,300	6,500	6,400	5,300	90
95					5,400	5,400	4,200	95
100					4,400	4,500	3,400	100
105					3,500	3,700	2,600	105
110					2,700	2,900		110

Mode 1 Optimized for best capacities on longer radius

Mode 2 Optimized for best capacities on short radius

Notes to lifting capacity

Lifting capacities do not exceed 85% of tipping load. Weight of hook blocks and slings is part of the load, and is to be deducted from the capacity ratings. Consult operation manual for further details.

Note: Data published herein is intended as a guide only and shall not be construed to warrant applicability for lifting purposes. Crane operation is subject to the computer charts and operation manual both supplied with the crane.

RANGE DIAGRAM - MAIN BOOM

RT 130

With Jib, 28.8 ft offset

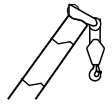

with hook ball: 7.5 ft
with hook block: 10 ft

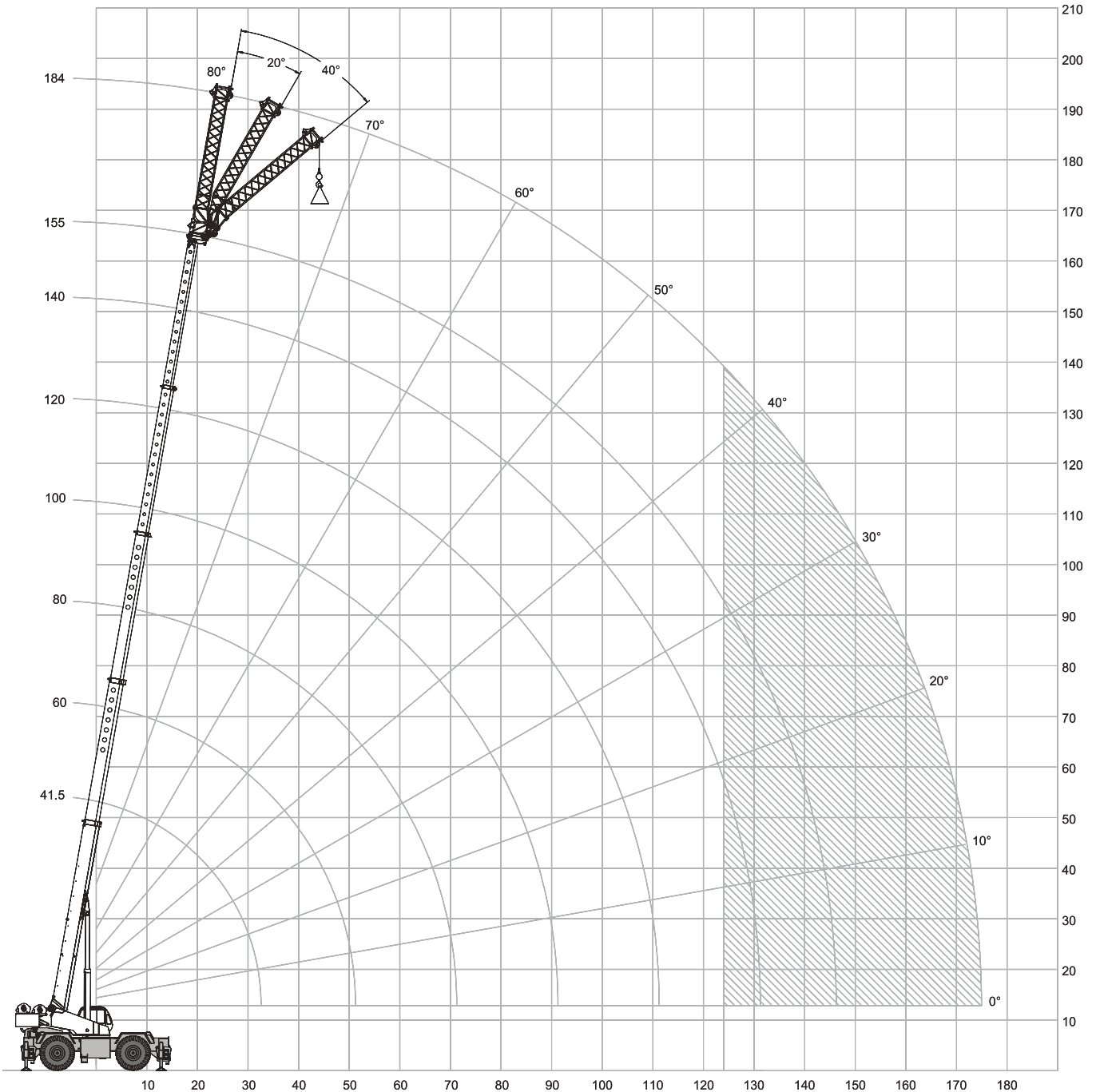



LOAD CHART- MAIN BOOM

RT 130

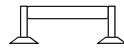

With Jib, 28.8 ft offset

 29,600 lbs counterweight

 Outriggers extended 26 ft (100%)

 360 degree rotation

Standard ASME B30.5

28.8 ft Offsettable Jib					
0° Offset		20° Offset		40° Offset	
 Radius (ft)	lbs	 Radius (ft)	lbs	 Radius (ft)	lbs
49	16,100	59	15,000	66	12,200
57	15,200	66	13,300	72	11,500
64	14,500	73	11,900	77	10,700
71	12,900	79	10,800	83	9,800
81	11,000	88	9,400	91	8,700
90	9,600	96	8,400	99	7,800
98	8,500	104	7,500	106	7,200
106	7,600	111	6,900	113	6,500
115	6,700	120	6,100	122	5,800
124	5,800	129	5,400	131	5,200
133	4,500	136	4,300	138	4,000
138	3,600	141	3,600		
148	2,400	151	2,300		
156	1,500	159	1,400		

Notes to lifting capacity

Lifting capacities do not exceed 85% of tipping load. Weight of hook blocks and slings is part of the load, and is to be deducted from the capacity ratings. Consult operation manual for further details.

Note: Data published herein is intended as a guide only and shall not be construed to warrant applicability for lifting purposes. Crane operation is subject to the computer charts and operation manual both supplied with the crane.

RANGE DIAGRAM - MAIN BOOM

RT 130

With Jib, 54.9 ft offset

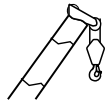

with hook ball: 7.5 ft
with hook block: 10 ft

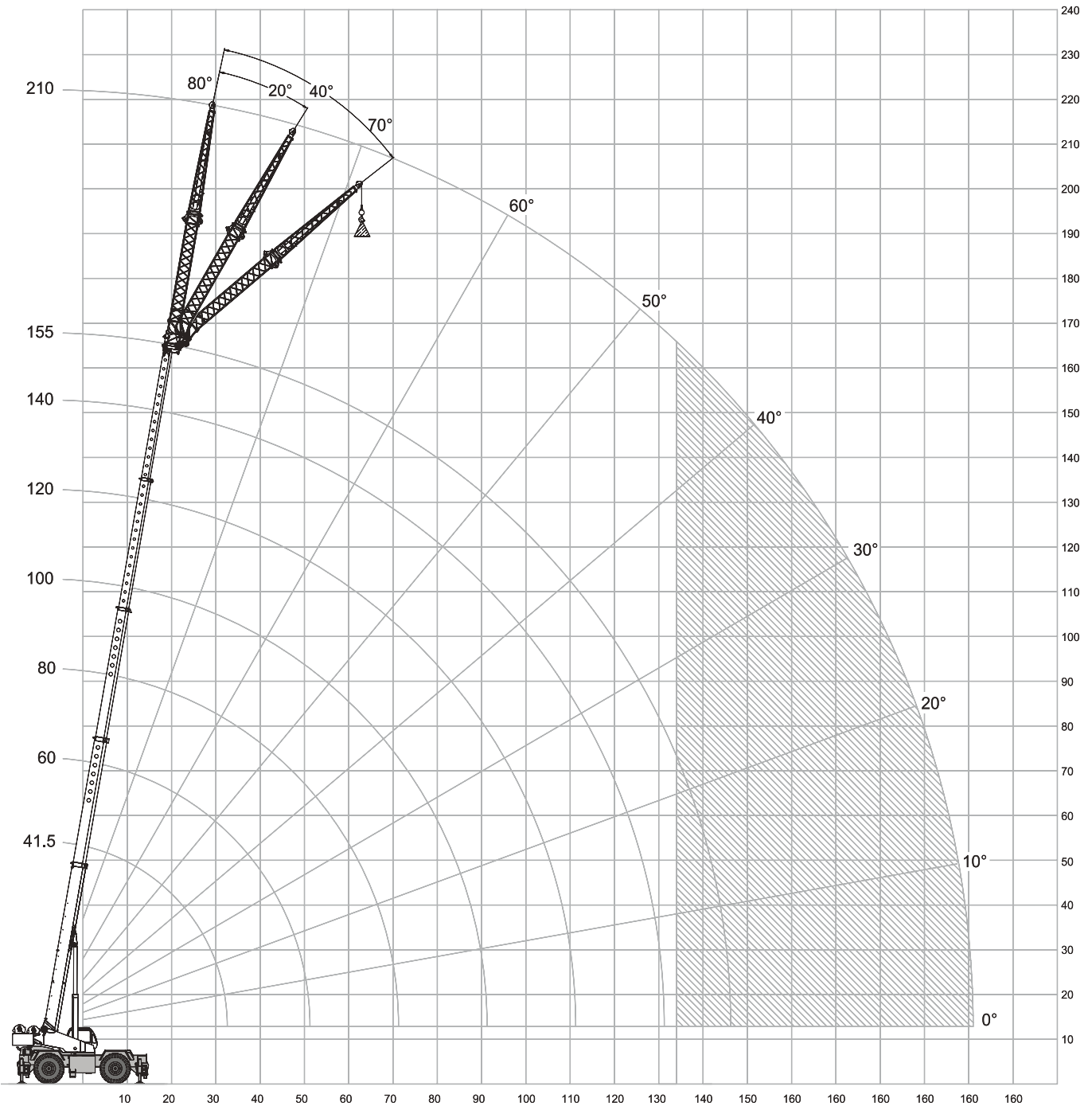



LOAD CHART- MAIN BOOM

RT 130



With Jib, 54.9 ft offset

 29,600 lbs counterweight

 Outriggers extended 26 ft (100%)

 360 degree rotation

Standard ASME B30.5

54.9 ft Offsettable Jib					
0° Offset		20° Offset		40° Offset	
 Radius (ft)	lbs	 Radius (ft)	lbs	 Radius (ft)	lbs
55	8,700	73	6,900	87	5,600
63	8,200	80	6,500	93	5,300
71	7,700	87	6,200	99	5,000
79	7,300	94	5,800	106	4,700
91	6,600	105	5,200	114	4,300
103	5,900	116	4,600	123	3,900
114	5,200	126	4,100	131	3,500
125	4,500	135	3,600	139	3,100
136	3,700	145	3,100	149	2,600
145	2,800	154	2,600	158	2,200
154	1,800	161	1,700	167	1,600
159	1,100	167	1,100		

Notes to lifting capacity

Lifting capacities do not exceed 85% of tipping load. Weight of hook blocks and slings is part of the load, and is to be deducted from the capacity ratings. Consult operation manual for further details.

Note: Data published herein is intended as a guide only and shall not be construed to warrant applicability for lifting purposes. Crane operation is subject to the computer charts and operation manual both supplied with the crane.

RANGE DIAGRAM - MAIN BOOM

RT 130

With Jib, 72.1 ft offset

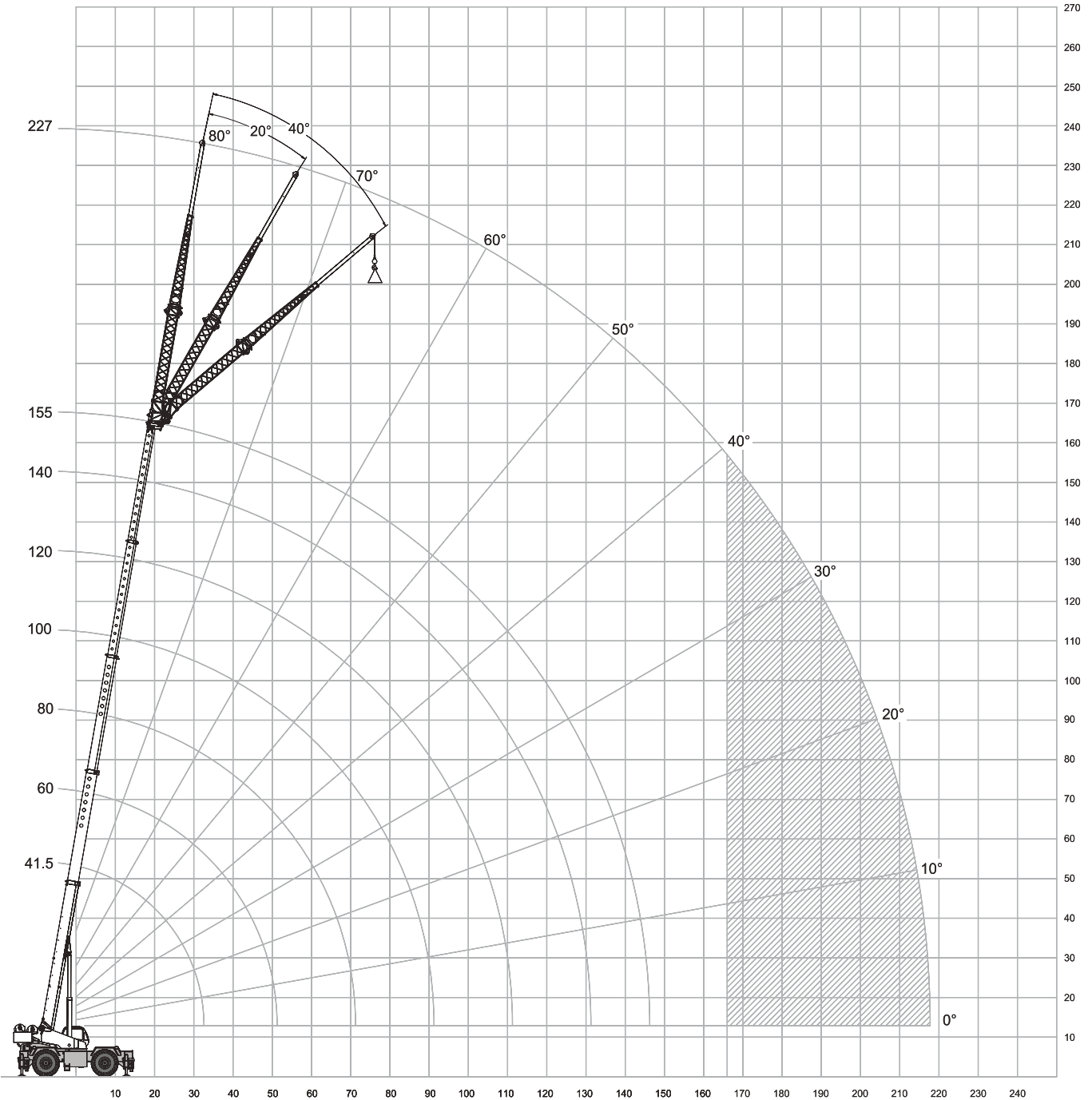
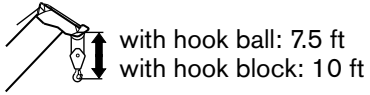
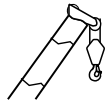



LOAD CHART- MAIN BOOM

RT 130

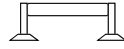

With Jib, 72.1 ft offset

 29,600 lbs counterweight

 Outriggers extended 26 ft (100%)

 360 degree rotation

Standard ASME B30.5

72.1 ft Offsettable Jib					
0° Offset		20° Offset		40° Offset	
 Radius (ft)	lbs	 Radius (ft)	lbs	 Radius (ft)	lbs
61	6,700	84	5,100	102	4,000
70	6,300	93	4,700	108	3,800
79	5,900	100	4,500	114	3,600
88	5,500	107	4,200	120	3,400
100	5,000	118	3,800	129	3,100
113	4,500	129	3,400	138	2,800
124	4,000	139	3,000	146	2,500
135	3,500	149	2,700	153	2,300
148	3,000	161	2,200	163	2,000
159	2,500	171	1,900	172	1,700
169	1,800	179	1,400	181	1,400
175	1,100				

Notes to lifting capacity

Lifting capacities do not exceed 85% of tipping load. Weight of hook blocks and slings is part of the load, and is to be deducted from the capacity ratings. Consult operation manual for further details.

Note: Data published herein is intended as a guide only and shall not be construed to warrant applicability for lifting purposes. Crane operation is subject to the computer charts and operation manual both supplied with the crane.

RANGE DIAGRAM - MAIN BOOM

RT 130

On Tires

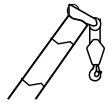

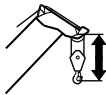
 with hook ball: 7.5 ft
with hook block: 10 ft

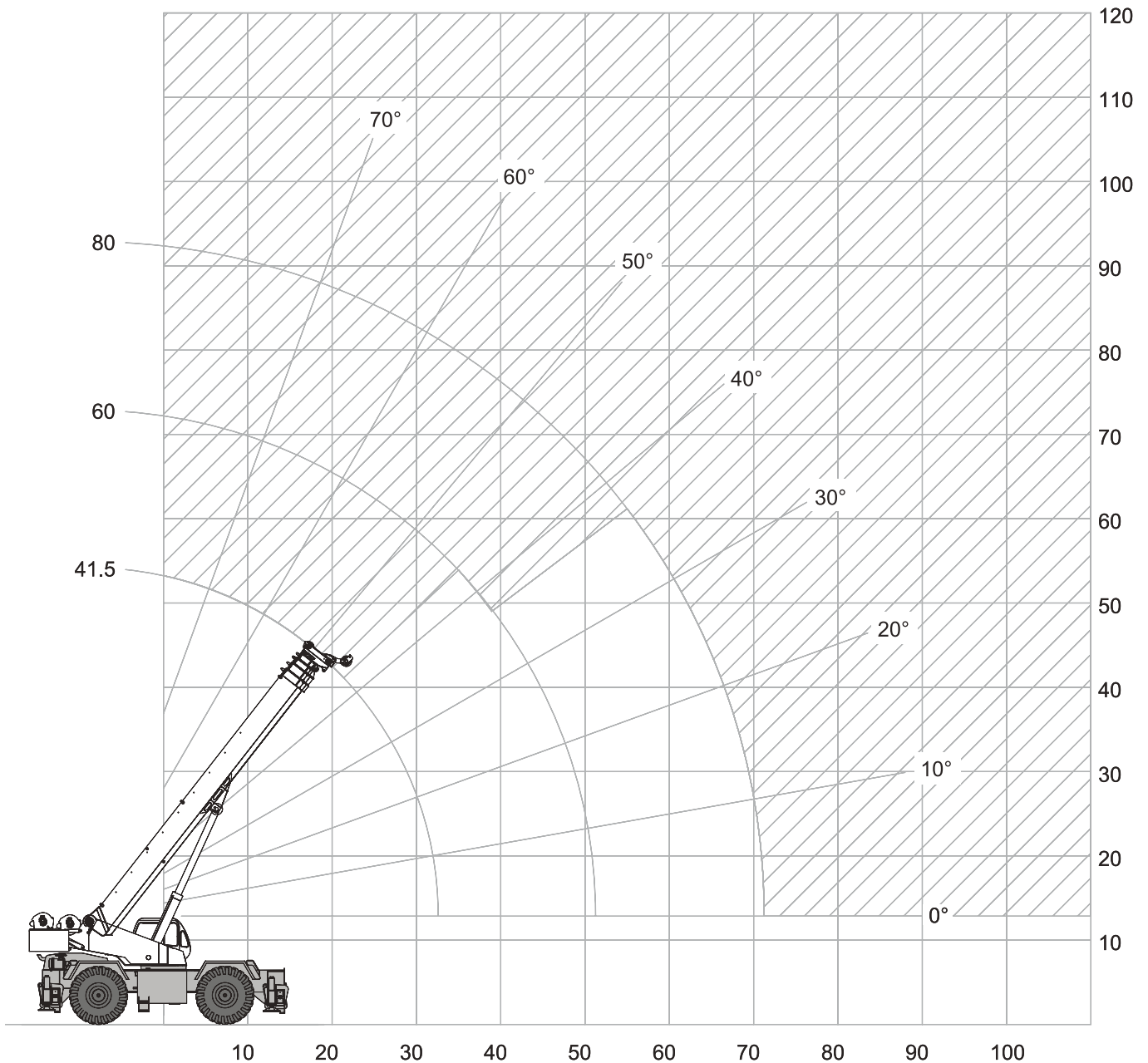

LOAD CHART- MAIN BOOM

RT 130

On Tires

 29,600 lbs counterweight

 On tires
33.25 x 29-32

Standard ASME
B30.5

Boom		Travel Speed Boom straight over front		
Radius	Length	0 mph	Creep	2.5 mph
ft	lb	lb	lb	lb
20	42	62,600	57,100	47,600
25	42	50,900	42,300	34,700
30	42	42,500	32,500	26,300
35	60	23,400	23,400	23,400
40	60	20,800	20,800	19,600
45	60	18,400	18,400	15,800
50	60	16,200	16,200	12,800
55	80	14,100	14,100	12,300
60	80	12,200	12,200	10,200
65	80	10,400	10,400	8,300
70	80	8,800	8,800	6,800

Notes to lifting capacity

Lifting capacities do not exceed 75% of tipping load. Weight of hook blocks and slings is part of the load, and is to be deducted from the capacity ratings. Consult operation manual for further details.

Note: Data published herein is intended as a guide only and shall not be construed to warrant applicability for lifting purposes. Crane operation is subject to the computer charts and operation manual both supplied with the crane.

RANGE DIAGRAM - MAIN BOOM

RT 130

Without Counterweight

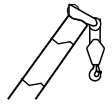

with hook ball: 7.5 ft
with hook block: 10 ft

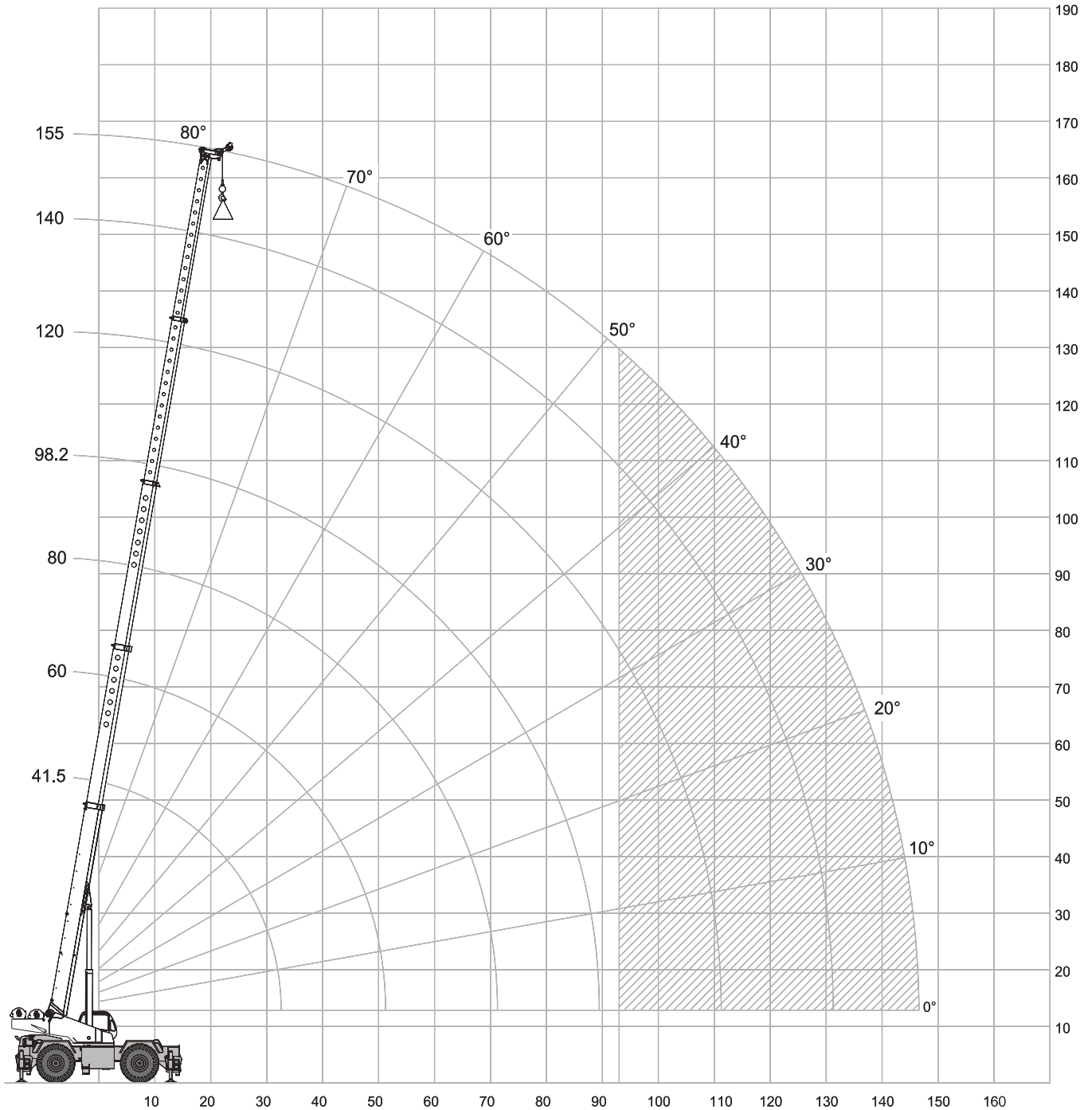



LOAD CHART- MAIN BOOM

RT 130

Without Counterweight

 0 lbs counterweight

 Outriggers extended 26 ft (100%)

 360 degree rotation

Standard ASME B30.5

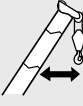
	Boom Length							
	41.5 ft	60 ft	80 ft	100 ft	120 ft	140 ft	155 ft	
ft	lb	lb	lb	lb	lb	lb	lb	ft
10	214,200							10
12	187,700	110,000						12
15	156,500	110,000	77,500					15
20	119,700	99,100	67,800	53,100				20
25	84,100	88,900	59,400	47,300	37,700			25
30	54,300	59,300	51,600	41,200	34,300	33,700		30
35	42,000	42,800	45,000	36,000	30,000	30,600	30,000	35
40		32,400	34,900	31,900	26,900	27,500	26,800	40
45		25,100	27,200	28,400	24,000	24,500	25,200	45
50		19,400	21,900	23,000	21,500	22,000	21,100	50
55		17,700	17,800	18,900	18,600	18,500	17,100	55
60			14,600	15,700	15,400	15,300	13,900	60
65			11,900	13,100	12,800	12,700	11,300	65
70			9,500	10,900	10,700	10,500	9,200	70
75			8,700	9,100	8,900	8,800	7,500	75
80				7,600	7,300	7,200	6,000	80
85				6,100	6,000	5,900	4,700	85
90				4,800	4,800	4,800	3,500	90
95				4,300	3,800	3,600	2,500	95
100					2,900	2,600	1,700	100
105					2,000	1,700	900	105
110					1,100	900		110

Notes to lifting capacity









Lifting capacities do not exceed 85% of tipping load. Weight of hook blocks and slings is part of the load, and is to be deducted from the capacity ratings. Consult operation manual for further details.

Note: Data published herein is intended as a guide only and shall not be construed to warrant applicability for lifting purposes. Crane operation is subject to the computer charts and operation manual both supplied with the crane.



TECHNICAL DESCRIPTION

RT 130

Boom

Standard configuration:	
	5 sections full power
	Mode 1: Optimized for best capacity on longer radius Mode 2: Optimized for best capacity on short radius
	Min. / Max. 41.5 ft / 155 ft
	Maximum tip height main boom 164 ft
	Boom elevation angle range (min. / max.) -3° / 80° Boom raising / lowering time 70 s / 100 s Boom extension / retraction time 115 s / 106 s
Optional configuration:	
	Single sheave Tip height - boom fully retracted / boom fully extended 54 ft / 165 ft
	Lattice style, side stow, bi-fold Pullout extension 28.8 ft / 54.9 ft Angular offsets 17.2 ft 0°, 20° and 40°
	With one jib section 184 ft With two jib sections 210 ft With two jib sections and pullout 227 ft
	With one jib section 193 ft With two jib sections 218 ft With two jib sections and pullout 235 ft

Hoist, Rope and Hook





Standard configuration:	
	Two speeds Grooved drum Storage capacity 1,239 ft
	Maximum without load 453 ft/min
	XIPS, IWRC, Right Regular Lay
	3/4 in
	850 ft
	Minimum breaking strength 58,800 lbs Maximum line pull permissible 16,800 lbs

Optional configuration:

	Two speeds Grooved drum Storage capacity	1,239 ft
	Maximum without load	453 ft / min
	Type: XIPS, IWRC, Right Regular Lay 35 x 7 rotation resistant compacted strand	
		3/4 in
		850 ft
	Minimum breaking strength Maximum line pull permissible	84,000 lbs 16,800 lbs
	Top swivel hook ball with latch 5 metallic sheaves 7 metallic sheaves 7 metallic sheaves 8 metallic sheaves	12 USt 75 USt 110 USt 130 USt 130 USt

Superstructure

Standard configuration:

	Weight Pinned to frame and hydraulically mounted / removed	14.8 USt
	Non stop Maximum rotation speed without load	360° 1.5 rpm
	Hydraulic motor Planetary reducer	
	Foot actuated pedal - provides variable braking force	
	Travel Lock - 2 position or 360° house lock	

Cab, Controls, Operator aids and Load limiter / Load indicator

Standard configuration:



Sliding door on the left side
 Sliding window on the left side and rear
 Hinged, tinted all glass skylight
 Six way adjustable and heated seat
 18° tiltable cab
 Work lights
 Signal lights indicating LMI-load



Armrest mounted dual axis electro-proportional joysticks
 Controls for hoist and hoist rotation indicator, slewing, boom elevation, boom telescoping
 Foot controls for swing brake, service brake and engine throttle
 Steering wheel column mounted controls for gear shifting
 Dashboard mounted switches for steering mode, outriggers



Graphic interface for rated capacity indicator



Standard HVAC, flameless heat



Diesel power heater

Optional configuration:

Carrier, Engine, Drive-line and Hydraulic system

Standard configuration:



Hydraulic, independent extension:

100% extended outrigger footprint area	693.3 ft ²
50% extended outrigger footprint area	483.9 ft ²
0% extended outrigger footprint area	283.3 ft ²
Floating ground bearing diameter (area)	24 in (452 in ²)
Single outrigger jack extending and retracting time	28 s
Single outrigger beam extending and retracting time	11 s

Access steps to the deck from any side



6 x 3 powershift transmission with torque converter
 4WD if traveling in 1st or 2nd gears forward or reverse
 Rigid mounted front axle
 Oscillating mounted rear axle
 Automatic rear axles oscillation lock when superstructure is swung by 10° from centerline in either directions
 Pneumatic service brakes



3 mode hydraulic power steering

Front wheel mode-minimum steering curb clearance radius	50.1 ft
All wheels cocentric steering mode - minimum steering curb clearance radius	28.2 ft

All wheels crab steering mode



Piston pump for main and auxiliary winch
 Piston pump for boom hoisting and telescoping
 Gear pump for steering, outriggers and slewing
 Hydraulic oil tank capacity

	304 gallons
--	-------------

Hydraulic oil filters

	10 µm
--	-------



Tier 4F

Cummins QSL9 6 cylinders

Rated power

320 hp @ 2,200 rpm

Maximum gross torque

1,050 ft-lb @ 1,500 rpm

Intake: turbocharger with intercooler

Fuel type

Ultra low sulfur diesel

Fuel tank capacity

80 gallons

Optional configuration:



Tier 3

Cummins QSC8.3 6 cylinders

Rated power

300 hp @ 2,200 rpm

Maximum gross torque

1,000 ft-lb @ 1,500 rpm

Intake: Turbocharger with intercooler

Fuel type

Diesel

Fuel tank capacity

80 gallons



Engine oil heater

Hydraulic oil heater

Battery heater

Low temp fluids

Vehicle performance

Standard configuration:

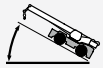

Maximum in 1st gear

79%

Maximum in 6th gear

5%



Maximum (6th gear)

20.4 mph



Maximum

+ 125° F

Minimum

-20° F

Tires

Standard configuration:



Wide tread - Earth mover pattern (E3)

33.25 x 29-32

Other options

Revolving amber light (One light mounted on the cab)

Yellow strobe light (One light mounted on the cab - used in place of revolving amber light)

Work light package (Lights mounted on the base of the boom and superstructure)

360-degree spotlight

Tire inflation kit

Mirror for viewing hoist

Battery disconnect switch

Front and/or rear pintle hook

Effective Date: October 2016. Product specifications and prices are subject to change without notice or obligation. The photographs and/or drawings in this document are for illustrative purposes only. Refer to the appropriate Operator's Manual for instructions on the proper use of this equipment. Failure to follow the appropriate Operator's Manual when using our equipment or to otherwise act irresponsibly may result in serious injury or death. The only warranty applicable to our equipment is the standard written warranty applicable to the particular product and sale and Terex makes no other warranty, express or implied. Products and services listed may be trademarks, service marks or trade-names of Terex Corporation and/or its subsidiaries in the USA and other countries. All rights are reserved. Terex® is a registered trademark of Terex Corporation in the USA and many other countries. Copyright 2016 Terex Corporation.

Terex Cranes, Global Marketing, Dingerstraße 24, 66482 Zweibrücken, Germany
Tel. +49 (0) 6332 830, Email: info.cranes@terex.com, www.terexcranes.com



www.terexcranes.com

Brochure Reference: TC-DS-I-E-RT 130-10/16



WORKS FOR YOU.™