

FLAT TOP TOWER CRANE

**Specifications:**

- ▶ Max jib length: 60,00 m
- ▶ Capacity at max length: 1,40 t
- ▶ Max capacity: 6,00 t

WORKS FOR YOU.™

KEY

Legenda · Zeichenerklärung · Légende · Leyenda · Legenda · Условные обозначения



Hoisting · Sollevamento · Heben · Levage · Elevación · Elevação · Подъем



Trolleying · Traslazione carrello · Kartzfahren · Distribution · Distribución · Distribuição · Передвижение каретки



Slewing · Rotazione · Schwenken · Orientation · Orientació · Giro · Поворот



Travelling · Traslazione · Schienenfahren · Translation · Traslación · Móvel · Передвижение



Directive on noise level · Direttiva sul livello acustico · Richtlinie für den Schall-Leistungspegel · Directive sur le niveau acoustique · Directiva sobre el nivel acustico · Diretiva sobre nível de ruídos · Директива по уровню шума



Consult us · Consultateci · Auf Anfrage · Nous consulter · Consultarnos · Consulte-nos · Проконсультироваться с нами



Power requirements · Potenza totale richiesta · Geforderte Stromstärke · Puissance totale nécessaire · Potencia necesaria · Requisitos de energia · Требования по питанию



Power supply · Alimentazione · Stromversorgung · Alimentation · Alimentación · Fonte de alimentação · Питание



In service · In servizio · In Betrieb · En service · En servicio · Em serviço · При работе



Out of service · Fuori servizio · Außer Betrieb · Hors service · Fuera de servicio · Fora de serviço · В режиме простоя



Max. under hook height · Altezza max. sotto gancio · Höchste Hakenhöhe · Hauteur maxi. sous crochet · Maxima altura bajo gancho · Alt. máx. sob o gancho · Макс высота крюка



Without load, without ballast, max. jib and max. height · A vuoto, senza zavorra, braccio max., altezza max. · Ohne Last und Ballast, mit Maximalausleger und Maximalhöhe · A vide, sans lest, avec flèche et hauteur maximum · Sin carga, sin lastre, con pluma y altura máxima · Sem carga, sem lastro, lança máxima, altura máxima · Без груза, без балласта, на макс. Длине вспомогательной стрелы и макс. Высоте



Counterweight · Zavorra controbraccio · Gegengewicht · Lest de contre-flèche · Lastre de contra flecha · Contrapeso · Противовес

C25

EN 14439-C25 · EN 14439 - C25 · EN14439 - C25 · EN 14439 - C25 · EN 14439 - C25 · EN 14439 - C25 · EN14439 - C25

CONTENTS

СТТ 132-6

Indice · Inhalt · Contenu · Contenido · Sumário · Содержание

Page · Pagina · Seite · Page · Página · Página · Страница:

Load Diagram · Diagramma di portata · Lastkurven · Courbes de charges · Curvas de cargas · Diagrama de carga · Диаграмма грузоподъёмности	4
Tower · Torre · Turm · Tour · Torre · Torre · Башня	7
Mechanisms · Meccanismi · Antriebe · Mécanismes · Mecanismos · Mecanismo · Механизм	10
Transportation · Trasporto · Transport · Transport · Transporte · Transporte · Транспортировка	12

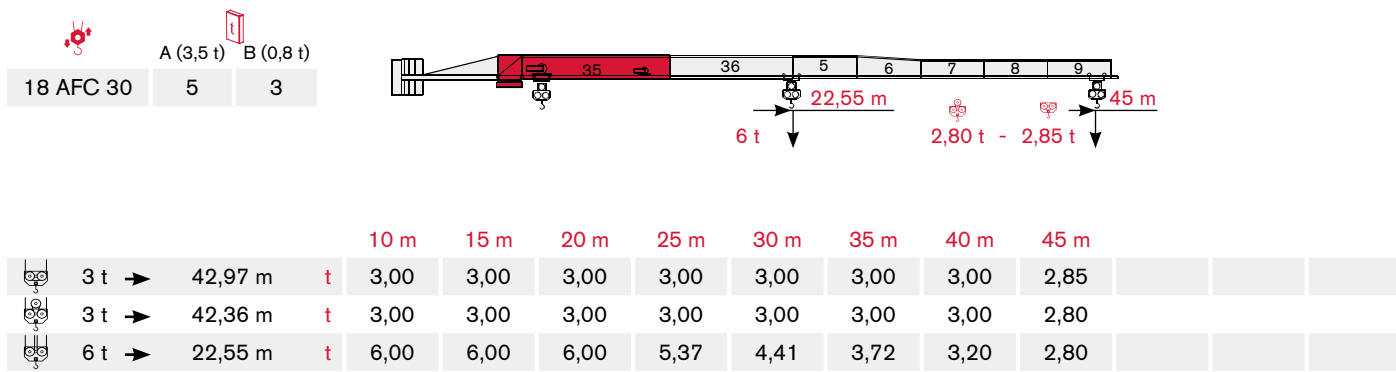
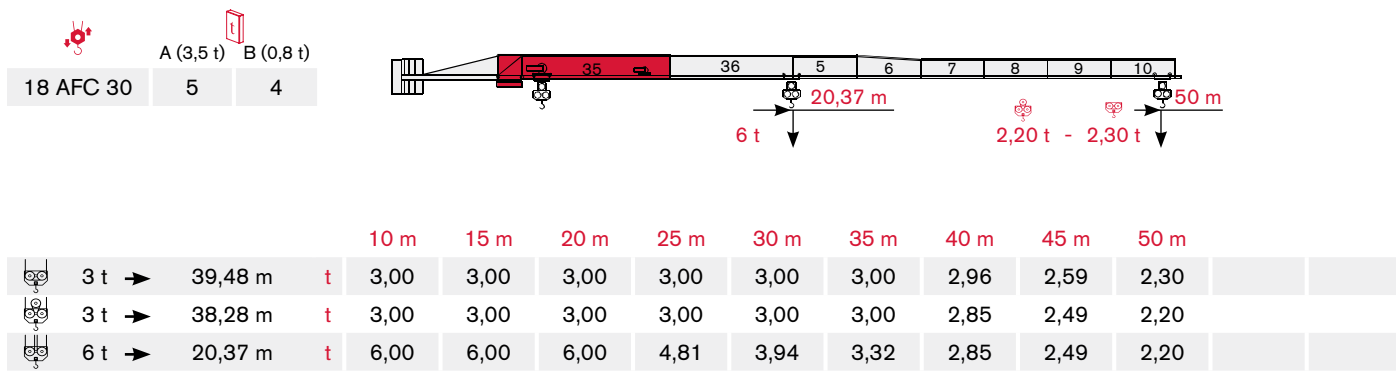
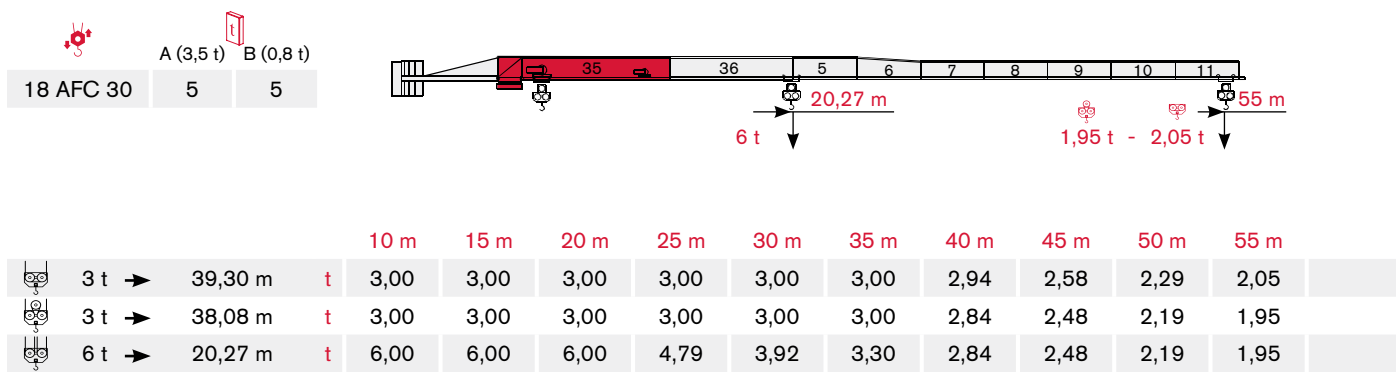
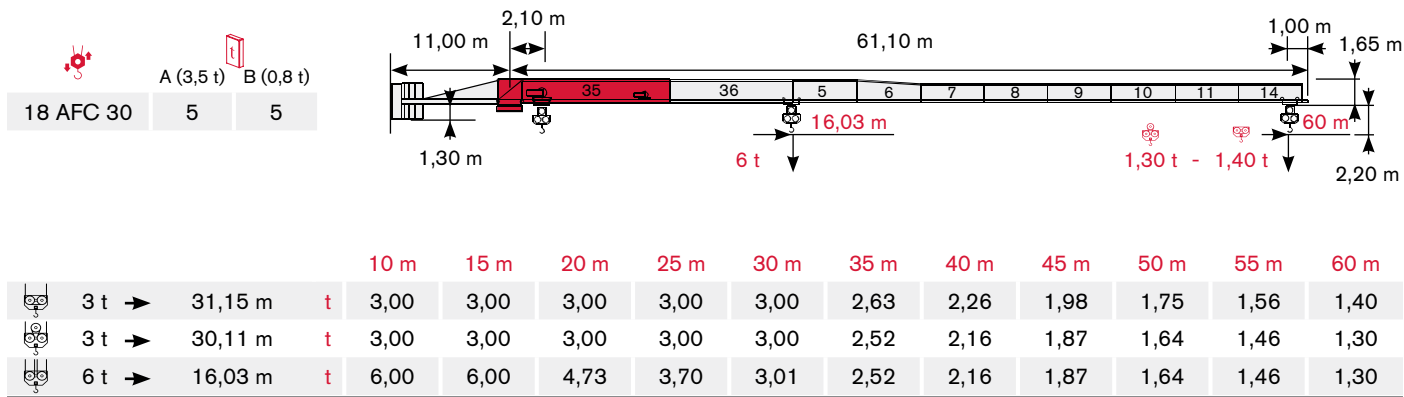

LOAD DIAGRAM

Diagramma di portata · Lastkurven · Courbes de charges · Curvas de cargas · Diagrama de carga · Диаграмма грузоподъёмности



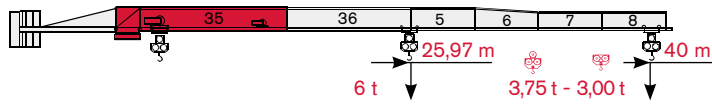

	A (3,5 t)	B (0,8 t)
18 AFC 30	5	2

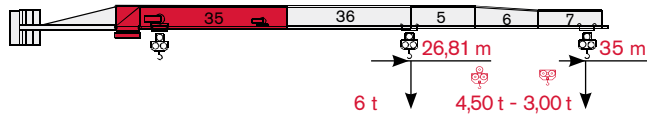

				10 m	15 m	20 m	25 m	30 m	35 m	40 m				
	3 t →	39,00 m	t	3,00	3,00	3,00	3,00	3,00	3,00	3,00				
	3 t →	39,00 m	t	3,00	3,00	3,00	3,00	3,00	3,00	3,00				
	6 t →	25,97 m	t	6,00	6,00	6,00	6,00	5,14	4,34	3,75				

	A (3,5 t)	B (0,8 t)
18 AFC 30	5	1



				10 m	15 m	20 m	25 m	30 m	35 m				
	3 t →	35,00 m	t	3,00	3,00	3,00	3,00	3,00	3,00				
	3 t →	35,00 m	t	3,00	3,00	3,00	3,00	3,00	3,00				
	6 t →	26,81 m	t	6,00	6,00	6,00	6,00	5,32	4,50				

	A (3,5 t)	B (0,8 t)
18 AFC 30	5	0

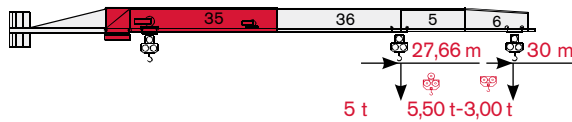

				10 m	15 m	20 m	25 m	30 m				
	3 t →	30,00 m	t	3,00	3,00	3,00	3,00	3,00				
	3 t →	30,00 m	t	3,00	3,00	3,00	3,00	3,00				
	6 t →	27,66 m	t	6,00	6,00	6,00	6,00	5,50				

LOAD DIAGRAM

Diagramma di portata · Lastkurven · Courbes de charges · Curvas de cargas · Diagrama de carga · Диаграмма грузоподъёмности

TEREX POWER PLUS

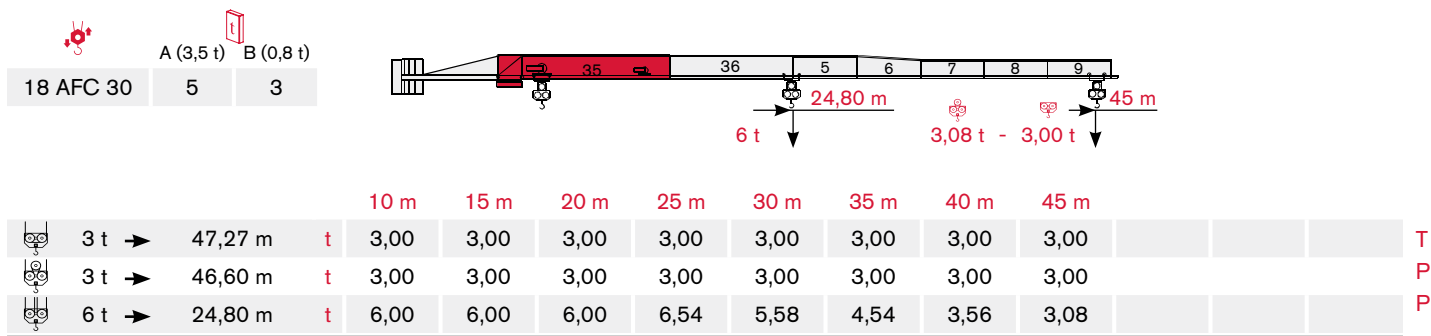
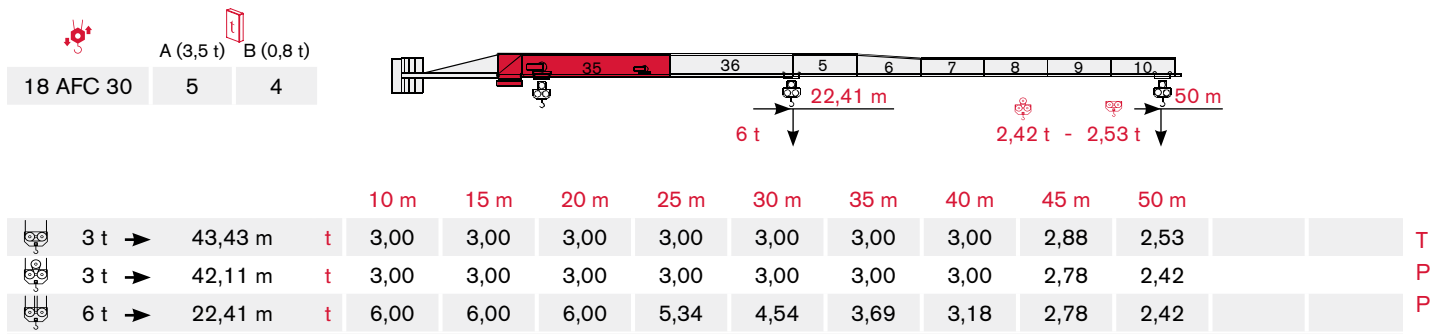
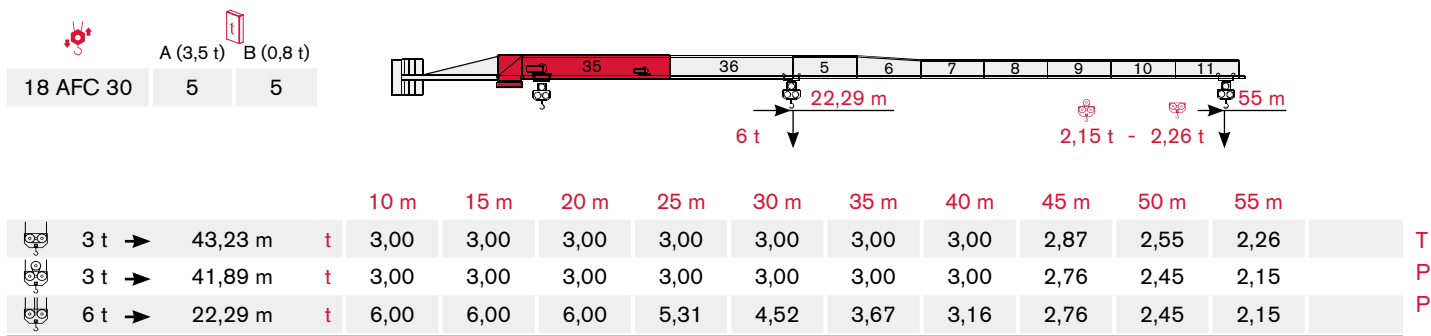
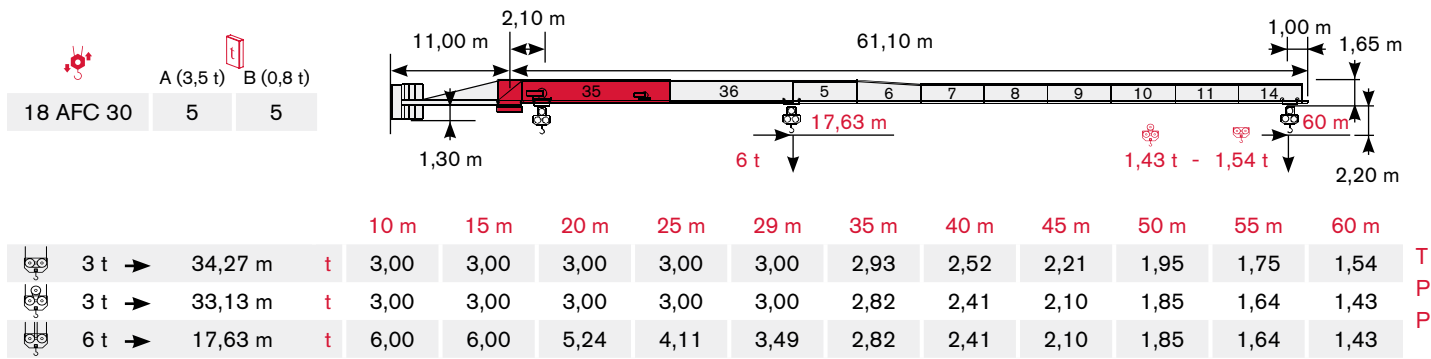

Standard Configurations · Installazioni Standard · Standardkonfiguration · Standard Implantations · Implantaciones Standard · Configuração padrão · Стандартная конфигурация крана

TS16

Tower: TS16 & Basement: R1

	●	◆
R1	-1515 kN	-1920 kN
R2	1200 kN	1622 kN
	355 kN	

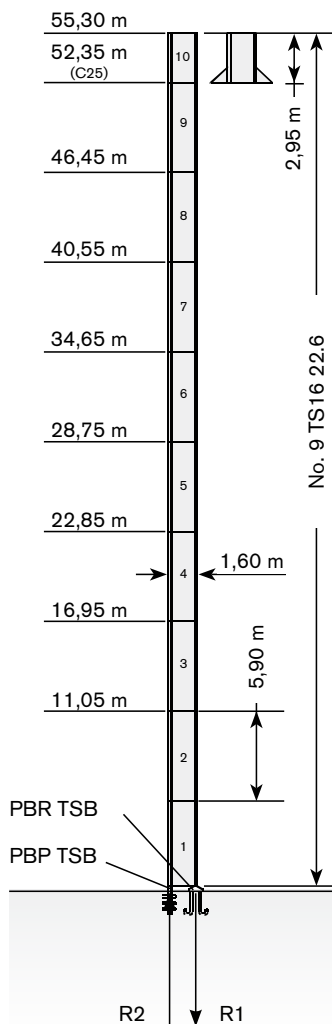

	max. H (m)	
	FEM 1001	FEM 1005 C25
30->40 m	55,30	52,35
45->60 m	52,35	49,40

Tower: TS16 & Basement: F1

	●	◆
R1	-860 kN	-1005 kN
R2	-55 kN	0 kN
	395 kN	

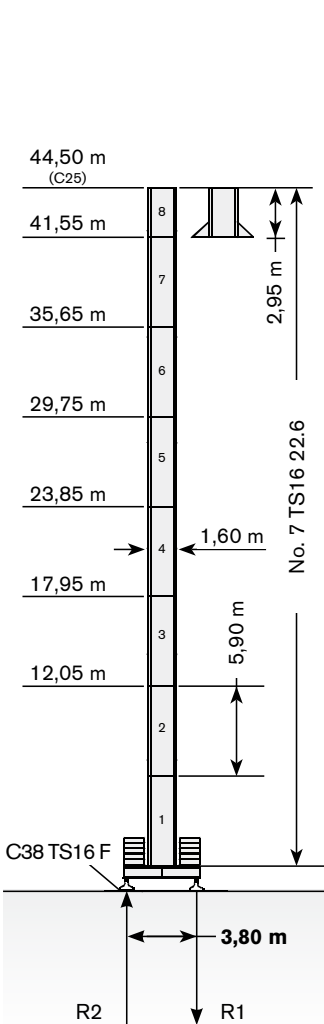

	max. H (m)	
	FEM 1001	FEM 1005 C25
30->40 m	44,50	44,50
45->60 m	44,50	44,50

Tower: TS16 & Basement: FP1

	●	◆
R1	-930 kN	-1165 kN
R2	-50 kN	0 kN
	405 kN	

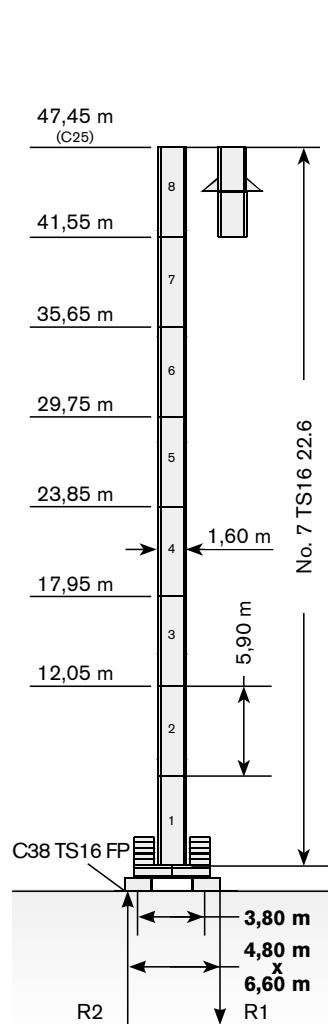

	max. H (m)	
	FEM 1001	FEM 1005 C25
30->40 m	47,45	47,45
45->60 m	47,45	47,45

Tower: TS16 & Basement: T1

	●	◆
R1	-900 kN	-860 kN
R2	0 kN	0 kN
	385 kN	

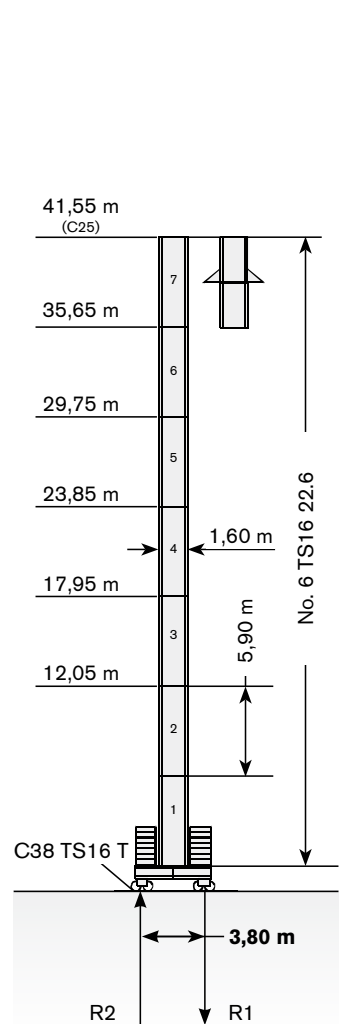

	max. H (m)	
	FEM 1001	FEM 1005 C25
30->40 m	41,55	41,55
45->60 m	41,55	41,55

Max. under hook height · Altezza max. sotto gancio · Höchste Hakenhöhe · Hauteur maxi. sous crochet · Maxima altura bajo gancho · alt. máx. sob o gancho · макс высота крюка

Different heights and tower combinations are available; please consult us · Altezze diverse e combinazioni di torre sono disponibili; consultateci · Andere Höhen und Turmkombinationen auf Anfrage · Différentes hauteurs et combinaisons de tour sont disponibles; nous consulter · Hay diferentes alturas y combinaciones de torre disponibles. Consúltenos · Diferentes alturas e combinações de torres disponíveis; fale conosco · Возможны другие сочетания высоты и конфигурации башни; проконсультируйтесь с нами

TOWER

Torre · Turm · Tour · Torre · Torre · Башня

Standard Configurations · Installazioni Standard · Standardkonfiguration · Standard Implantations · Implantaciones Standard · Configuração padrão · Стандартная конфигурация крана

TS16

Tower: TS16 & Basement: F2

	●	◆
R1	-830 kN	-1025 kN
R2	-55 kN	0 kN
	435 kN	

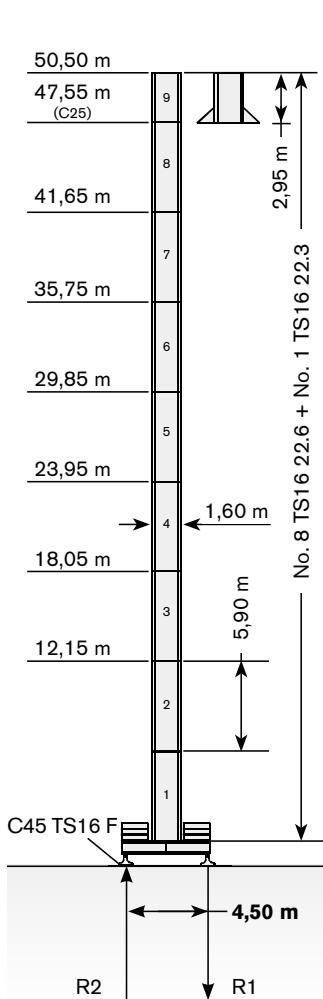

	max. H (m)	
	FEM 1001	FEM 1005 C25
30->40 m	50,50	47,55
45->60 m	50,50	47,55

Tower: TS16 & Basement: FP2

	●	◆
R1	-880 kN	-1025 kN
R2	-65 kN	0 kN
	425 kN	

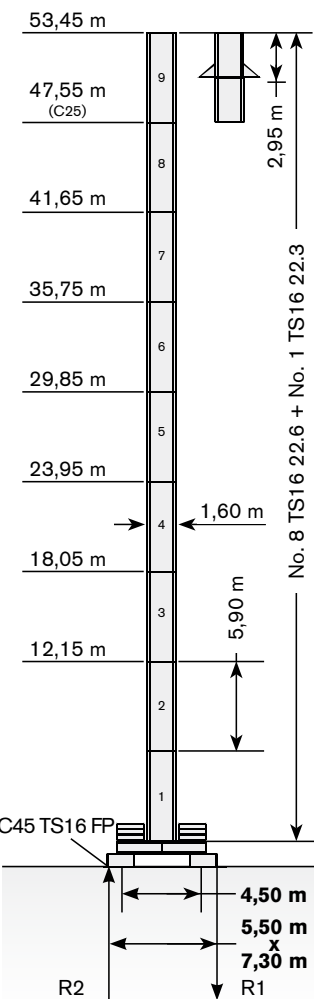

	max. H (m)	
	FEM 1001	FEM 1005 C25
30->40 m	53,45	47,55
45->60 m	50,50	47,55

Tower: TS16 & Basement: T2

	●	◆
R1	-920 kN	-1025 kN
R2	0 kN	0 kN
	435 kN	

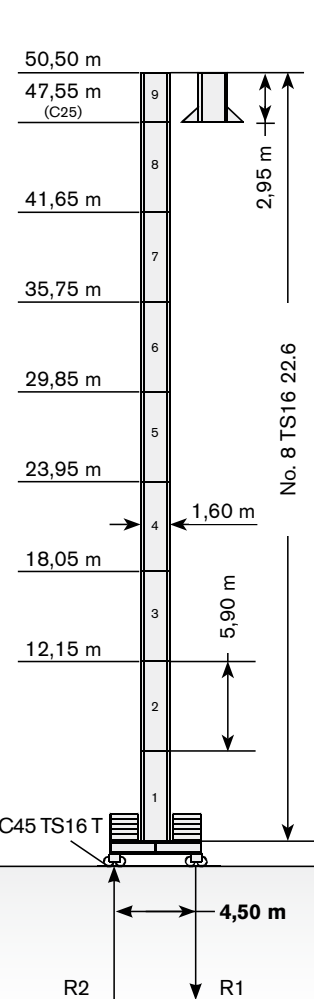

	max. H (m)	
	FEM 1001	FEM 1005 C25
30->40 m	50,50	47,55
45->60 m	50,50	47,55

TS16 22.3 TC tower section for Top Climbing ·

Prolunga TS16 22.3 TC sopraelevazione con gabbia di telescopaggio ·

Turmelement TS16 22.3 TC für Turm-Erhöhung mit Kletterwerk ·

Pylône tour TS16 22.3 TC pour surélévation avec cage télescopique ·

Columna torre TS16 22.3 TC por sobreelevación con jaula ·

TS16 22.3 TC elemento de torre para telescopagem ·

S16 22.3 TC секция башни TC для унаращивания крана

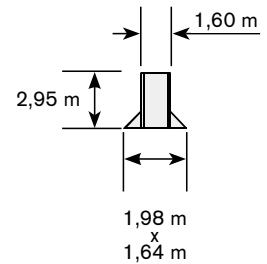

The available lengths for the TS tower sections are 11.8 m, 5.9 m, 2.95 m. · Le prolunge TS sono disponibili in lunghezze 11.8 m, 5.9 m, 2.95 m. · Die Turmschüsse TS sind mit Längen 11.8 m, 5.9 m, 2.95 m verfügbar. · Les éléments de mât TS sont disponibles en longueur 11.8 m, 5.9 m, 2.95 m. · Los tramos de torre TS son disponibles en las medidas de largo 11.8 m, 5.9 m, 2.95 m. · Os comprimentos disponíveis para elementos de torre TS são: 11.8m, 5.9m e 2.95m. · Длина поставляемых секций башни TS - 11.8 m, 5.9 m, 2.95 m.

Torre · Turm · Tour · Torre · Torre · Башня

Other configurations · Altre Installazioni · Aufstellmöglichkeiten · Autres Implantations · Otras Implantaciones · Outras configurações · Другие конфигурации

Bottom climbing crane · Gru climbing · Kletterkran im Gebäude · Télescopage sur dalles · Telescopage grúa trepadora · Guindaste automontante interno · Самоподъемный кран

Crane tied to the structure · Gru ancorata · Geankerter Kran · Grue ancrée · Grúa anclada · Guindaste ancorado na estrutura · Кран, крепящийся к сооружению

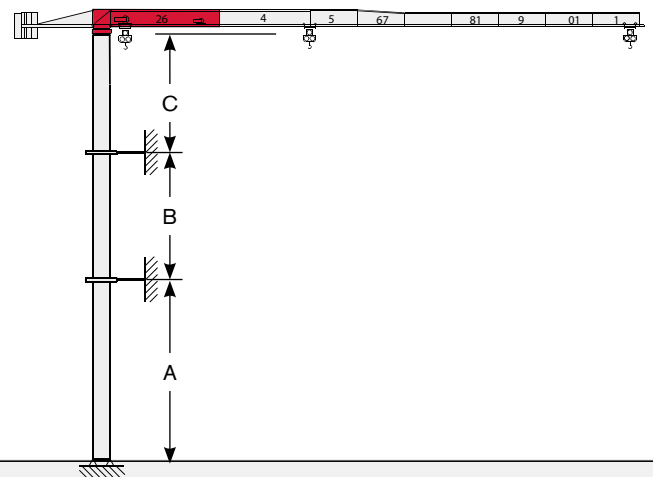
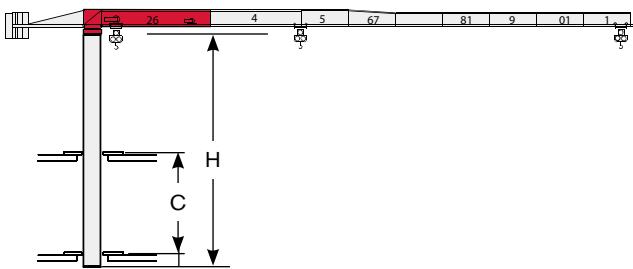

Tower: TS16

Jib	C min/max (m)	H min/max (m)
29 - 39	11/13	29,5/41,3
44 - 59	11/13	29,5/38,35

Tower: TS16

Jib	A min/max (m)	B min/max (m)	C max (m)
29 - 39	33/43	17,7/23,6	28
44 - 59	30/40	17,7/23,6	28







Different heights and tower combinations are available; please consult us ▪ Altezze diverse e combinazioni di torre sono disponibili; consultateci ▪ Andere Höhen und Turmkombinationen auf Anfrage ▪ Différentes hauteurs et combinaisons de tour sont disponibles; nous consulter ▪ Hay diferentes alturas y combinaciones de torre disponibles. Consultémos ▪ Diferentes alturas e combinações de torres disponíveis; fale conosco ▪ Возможны другие сочетания высоты и конфигурации башни; проконсультируйтесь с нами

MECHANISMS





Meccanismi · Antriebe · Mécanismes · Mecanismos · Mecanismo · Механизм

Power supply · Alimentazione · Stromversorgung · Alimentation · Suministro eléctrico · Requisitos de energia · Требования по питанию

	18 AFC 30	 46 kVA*	 400V - 50Hz / 460V - 60Hz	 2000/14/CE modificata
---	-----------	---	---	---

* Average consumption · Consumo medio · Durchschnittsverbrauch · Consommation moyenne · Consumo medio · Consumo médio · Среднее потребление

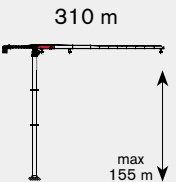
Hoisting · Sollevamento · Heben · Levage · Elevación · Elevação · Подъем

			t	m/min	kW	
	18 AFC 30		3	0 → 32	18	
			2	0 → 44		
			1,5	0 → 58		
			1,25	0 → 68		
			1	0 → 80		
			6	0 → 16		
			4	0 → 22		
			3	0 → 29		
			2,5	0 → 34		
			2	0 → 40		

Hoisting Speed · Velocità di Sollevamento · Heben Geschwindigkeit · Vitesse de Levage · Velocidad de Elevación · Velocidade de içamento · Скорость подъема

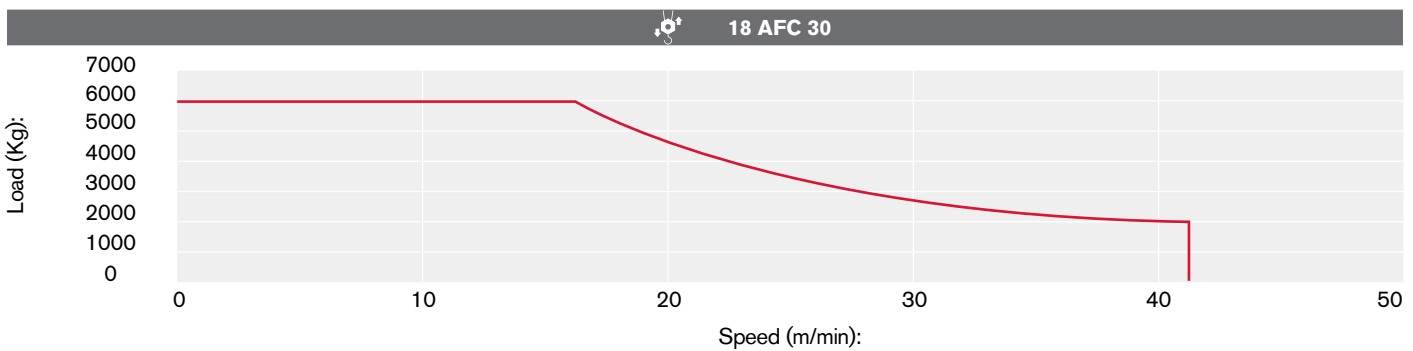
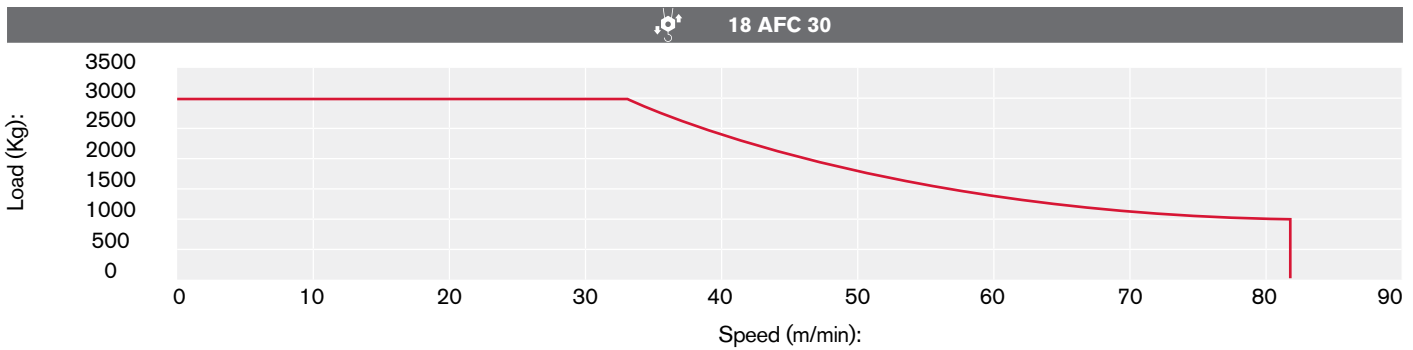

Additional Specifications · Altre movimentazioni · Weitere Leistungsdaten · Spécifications additionnelles · Otras prestaciones · Especificações adicionais · Дополнительные спецификации

	DVF 3 4 D8	0 → 6 → 30 → 70 m/min	4 kW
	SVF 1 1 8	0,9 r.p.m. (50Hz)	7,5 kW
	TAD 2RP 2M3	0 → 24 m/min (50Hz) 0 → 29 m/min (60Hz)	2 x 3 kW
	TAD 2RG 4M3	0 → 24 m/min (50Hz) 0 → 29 m/min (60Hz)	4 x 3 kW

Tower height max.





		T1	T2
	TAD 2RP 2M3	29,75 m	35,65 m
	TAD 2RG 4M3	> 29,75 m	> 35,65 m

TRANSPORTATION

Trasporto · Transport · Transport · Transporte · Transporte · Транспортировка

Packing list

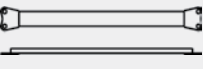
Undercarriage

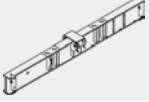
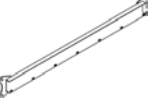
CTT 132-6	DESCRIPTION · DESCRIZIONE · BESCHREIBUNG · DESCRIPTION · DESCRIPCION · DESCRIÇÃO · ОПИСАНИЕ	LENGTH · LUNGHEZZA · LÄNGE · LONGUEUR · LONGITUD · COMPRIMENTO · ДЛИНА	WIDTH · LARGHEZZA · BREITE · LARGEUR · ANCHURA · LARGURA · ШИРИНА	HEIGHT · ALTEZZA · HÖHE · HAUTEUR · ALTURA · ALTURA · · ВЬСОТА	QUANTITY · QUANTITÀ · MENGE · QUANTITÉ · · CANTIDAD · QUANTIDADE · КОЛИЧЕСТВО	WEIGHT · PESO · GEWICHT · POIDS · PESO · PESO · ВЕС
	"A" BEAM FOR C38 UNDERCARRIAGE TS16	5,80 m	0,41 m	0,80 m	1	2050 kg
	"B" BEAM FOR C38 UNDERCARRIAGE TS16	5,80 m	0,75 m	0,70 m	1	2050 kg
	CROSSBEAM FOR C38 UNDERCARRIAGE	3,70 m	0,11 m	0,40 m	2	190 kg
	"A" BEAM C45 UNDERCARRIAGE TS21-TS16	6,80 m	0,40 m	1,00 m	1	2820 kg
	"B" BEAM C45 UNDERCARRIAGE TS21-TS16	6,80 m	0,75 m	0,80 m	1	2620 kg
	CROSSBEAM FOR C45 UNDERCARRIAGE TS21-TS16	4,40 m	0,12 m	0,54 m	2	230 kg

Tower

	TS16 22.3 TOWER SECTION	1,60 m	1,60 m	2,98 m	1	1215 kg*
	TS16 22.6 TOWER SECTION	1,60 m	1,60 m	5,93 m	1	2260 kg*
	TS16 22.12	1,60 m	1,60 m	11,83 m	1	4400 kg
	CTT 121/A TS16 TOP CLIMBING UNIT TOWER SECTION MOUNT	2,50 m	2,00 m	3,00 m	1	1893 kg*

* Inclusive of ladder, ladder support and protection, platform

TRANSPORTATION













CTT 132-6

Trasporto · Transport · Transport · Transporte · Transporte · Транспортировка

Cab

CTT 132-6	DESCRIPTION · DESCRIZIONE · BESCHREIBUNG · DESCRIPTION · DESCRIPCION · DESCRIÇÃO · ОПИСАНИЕ	LENGTH · LUNGHEZZA · LÄNGE · LONGUEUR · LONGITUD · COMPRIMENTO · ДЛИНА	WIDTH · LARGHEZZA · BREITE · LARGEUR · ANCHURA · LARGURA · ШИРИНА	HEIGHT · ALTEZZA · HÖHE · HAUTEUR · ALTURA · ALTURA · · ВИСОТА	QUANTITY · QUANTITÀ · MENGE · QUANTITÉ · · CANTIDAD · QUANTIDADE · КОЛИЧЕСТВО	WEIGHT · PESO · GEWICHT · POIDS · PESO · PESO · ВЕС
	PLATFORM UNIT INCLUDING CAB EVO15	3,00 m	2,70 m	3,70 m	1	1500 kg

Upper Part

	JIB SECTION-36	10,00 m	1,11 m	1,80 m	1	1408 kg
	JIB SECTION-5	5,20 m	1,11 m	1,80 m	1	530 kg
	JIB SECTION-6	5,20 m	1,11 m	1,80 m	1	510 kg
	JIB SECTION-7	5,20 m	1,11 m	1,30 m	1	450 kg
	JIB SECTION-8	5,20 m	1,11 m	1,30 m	1	400 kg
	JIB SECTION-9	5,20 m	1,11 m	1,30 m	1	300 kg
	JIB SECTION-10	5,20 m	1,11 m	1,30 m	1	246 kg
	JIB SECTION-11	5,20 m	1,11 m	1,30 m	1	200 kg
	JIB SECTION-14	5,20 m	1,11 m	1,30 m	1	170 kg
	JIB POINT	1,20 m	0,70 m	1,10 m	1	55 kg
	BALLAST BASKET	1,20 m	0,75	2,70	1	265 kg
	COUNTERJIB COMPLETE	9,70 m	1,40 m	0,75 m	1	2240 kg
	SLEWING UNIT INCLUDING JIB SECTION-35	11,82 m	2,00 m	2,50 m	1	7310 kg

NOTES

Appunti · Notizen · Note · Apunte · Notas · Заметки

TEREX CRANES

Tower Cranes

Via delle Innovazioni, 17
33074 Fontanafredda (PN)
Italy

Ph: +39 0434 989111
Email: info.cranes@terex.com

Rough Terrain Cranes

Via Cassoletta, 76 - Fraz. Crespellano
40053 Valsamoggia (BO)
Italy

Ph: +39 051 6501011
Email: info.cranes@terex.com

December 2019. Product specifications and prices are subject to change without notice or obligation. The photographs and/or drawings in this document are for illustrative purposes only. Refer to the appropriate Operator's Manual for instructions on the proper use of this equipment. Failure to follow the corresponding Operator's Manual when using our equipment or to otherwise act responsibly may result in serious injury or death. The only warranty applicable to our equipment is the standard written warranty applicable to the particular product and sale and Terex makes no other warranty, express or implied. Products and services listed may be trademarks, service marks or trade-names of Terex Corporation and/or its subsidiaries in the USA and other countries. All rights are reserved. Terex, the Terex Crown design and Works For You are trademarks of Terex Corporation or its subsidiaries.

Dicembre 2019. Specifiche e prezzi dei prodotti sono soggetti a modifica senza preavviso o altro obbligo. Le fotografie e i disegni in questo documento hanno esclusivamente scopo illustrativo. Consulta il Manuale dell'operatore pertinente per trovare istruzioni per l'utilizzo corretto di questo macchinario. La mancata osservanza delle istruzioni contenute nel relativo Manuale dell'operatore durante l'uso del macchinario e altri comportamenti irresponsabili possono provocare gravi lesioni, anche mortali. L'unica garanzia applicabile ai nostri macchinari è la garanzia scritta standard applicabile al particolare prodotto e alla particolare vendita e Terex è esonerata dal fornire qualsiasi altra garanzia, esplicita o implicita. I prodotti e servizi elencati possono essere dei marchi di fabbrica, marchi di servizio o nomi commerciali di Terex Corporation, e/o delle rispettive società affiliate negli Stati Uniti d'America e in molte altre nazioni. Tutti i diritti riservati. Terex, il marchio Terex Crown e Works for You sono marchi di proprietà di Terex Corporation o delle sue società affiliate.

Dezember 2019. Irrtum und Änderungen der Produktspezifikationen vorbehalten. Die in diesem Dokument enthaltenen Fotos und/oder Zeichnungen dienen rein anschaulichen Zwecken. Für den sachgemäßen Gebrauch der Maschinen ist das entsprechende Bedienerhandbuch heranzuziehen. Unsachgemäßer Umgang mit bzw. unsachgemäßer Einsatz unserer Maschinen kann zu schweren gesundheitlichen Schäden bis hin zum Tod führen. Für unsere Produkte wird ausschließlich die entsprechende, schriftlich niedergelegte Standardgarantie gewährt. Terex leistet keinerlei darüber hinausgehende Garantie, weder ausdrücklich noch stillschweigend. Die genannten Produkte und Dienstleistungen sind in den USA und anderen Ländern ggf. Marken, Dienstleistungsmarken oder Handelsnamen der Terex Corporation und/oder ihrer Tochtergesellschaften. Alle Rechte vorbehalten. Terex, das Terex Kronenlogo und Works For You sind Marken in Eigentum der Terex Corporation bzw. ihrer Tochtergesellschaften.

Décembre 2019. Les caractéristiques et prix des produits peuvent faire l'objet de modifications sans notification préalable. Les photographies ou dessins présentés dans ce document servent uniquement à des fins d'illustration. Pour connaître les instructions relatives à l'utilisation correcte de cet équipement, veuillez vous référer au manuel de l'utilisateur correspondant. Le non-respect du manuel d'utilisateur correspondant lors de l'utilisation de notre équipement ou des actes irresponsables risquent de provoquer de graves blessures, voire un décès. La seule garantie applicable à nos équipements est la garantie écrite standard applicable au produit et à la vente spécifiques. Terex ne délivre aucune autre garantie, expresse ou implicite. Les produits et les services mentionnés peuvent être des marques, des marques de service ou des appellations commerciales de Terex Corporation et/ou de ses filiales aux États-Unis et dans d'autres pays. Tous droits réservés. Terex, le design Terex Crown et Works For You sont des marques déposées de Terex Corporation ou de ses filiales.

Diciembre 2019. Las especificaciones y los precios de los productos están sujetos a cambios sin necesidad de previo aviso ni ninguna otra obligación. Las fotografías y/o dibujos de este documento tienen un fin meramente ilustrativo. Consulte el correspondiente manual de instrucciones del operario para obtener más información sobre el uso correcto de esta maquinaria. No respetar el manual del operario al utilizar la maquinaria o actuar de forma irresponsable puede provocar lesiones graves e incluso mortales. La única garantía aplicable a nuestra maquinaria es la garantía escrita estándar de cada producto y venta. Terex no amplía dicha garantía de forma expresa ni implícita. Los productos y servicios mencionados pueden ser marcas comerciales, marcas de servicio o nombres de marca de Terex Corporation o de alguna de sus filiales en Estados Unidos y otros países. Todos los derechos reservados. Terex, el diseño de la corona Terex y Works For You son marcas registradas de Terex Corporation o de sus filiales.

Dezembro 2019. Especificações e preços dos produtos sujeitos a alteração sem aviso prévio ou obrigações. As fotografias e/ou desenhos neste documento são apenas para fins ilustrativos. Consulte o respectivo Manual do Operador para instruções sobre o uso correto deste equipamento. Deixar de acompanhar o respectivo Manual do Operador ao usar o nosso equipamento ou, por qualquer outra forma, deixar de agir de maneira responsável pode resultar em lesões corporais graves ou a morte. A única garantia aplicável ao nosso equipamento é a garantia padrão por escrito correspondente ao produto específico vendido. A Terex não dá outras garantias, expressas ou implícitas. Os produtos e serviços listados podem ser marcas comerciais, marcas de serviço ou nomes-fantasia da Terex Corporation e/ou suas subsidiárias nos EUA e em outros países. Todos os direitos reservados. Terex, o desenho da Coroa Terex e a expressão Works For You são marcas comerciais da Terex Corporation ou suas subsidiárias.

декабрь 2019 г. года Технические характеристики и цены могут изменяться без предварительного уведомления и без каких-либо обязательств для производителя. Фотографии и (или) чертежи в настоящем документе служат только в качестве иллюстраций. Инструкции по надлежащей эксплуатации данного оборудования см. в соответствующем руководстве для оператора. Невыполнение указаний соответствующих руководств для оператора при эксплуатации оборудования или другие безответственные действия могут повлечь серьезные травмы или смерть. Единственной гарантией, действующей в отношении нашего оборудования, является стандартная форма письменной гарантии на данный тип оборудования и на условия его продажи. Terex не дает никаких других гарантий: ни ясно выраженных, ни подразумеваемых. Перечисленные продукты и услуги могут быть торговыми марками, знаками обслуживания или торговыми наименованиями Terex Corporation и / или ее дочерних компаний в США и других странах. Все права защищены. Terex, изображение короны Terex и Works for You являются торговыми марками, принадлежащими корпорации Terex или ее дочерним компаниям.



www.terex.com/cranes

Brochure Reference: TC-DS-M-E//G/F/S/P/R-CTT132-6-12/19



WORKS FOR YOU.™