

FLAT TOP TOWER CRANE

Specifications:

- ▶ Max jib length: 84,00 m
- ▶ Capacity at max length: 1,50 t
- ▶ Max capacity: 32,00 t



T-Link



Zoning

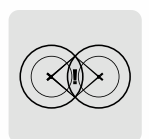

Anticollision

WORKS FOR YOU.™

KEY

Legenda · Zeichenerklärung · Légende · Leyenda · Legenda · Условные обозначения



Hoisting · Sollevamento · Heben · Levage · Elevación · Elevação · Подъем



Trolleying · Traslazione carrello · Katzfahren · Distribution · Distribución · Distribuição · Передвижение каретки



Slewing · Rotazione · Schwenken · Orientation · Orientació · Giro · Поворот



Travelling · Traslazione · Schienenfahren · Translation · Traslación · Móvel · Передвижение



Directive on noise level · Direttiva sul livello acustico · Richtlinie für den Schall-Leistungspegel · Directive sur le niveau acoustique · Directiva sobre el nivel acustico · Diretiva sobre nível de ruídos · Директива по уровню шума



Consult us · Consultateci · Auf Anfrage · Nous consulter · Consultarnos · Consulte-nos · Проконсультироваться с нами



Power requirements · Potenza totale richiesta · Geforderte Stromstärke · Puissance totale nécessaire · Potencia necesaria · Requisitos de energia · Требования по питанию



Power supply · Alimentazione · Stromversorgung · Alimentation · Alimentación · Fonte de alimentação · Питание



In service · In servizio · In Betrieb · En service · En servicio · Em serviço · При работе



Out of service · Fuori servizio · Außer Betrieb · Hors service · Fuera de servicio · Fora de serviço · В режиме простоя



Max. under hook height · Altezza max. sottogancio · Höchste Hakenhöhe · Hauteur maxi. sous crochet · Maxima altura bajo gancho · Alt. máx. sob o gancho · Макс высота крюка



Without load, without ballast, max. jib and max. height · A vuoto, senza zavorra, braccio max., altezza max. · Ohne Last und Ballast, mit Maximalausleger und Maximalhöhe · A vide, sans lest, avec flèche et hauteur maximum · Sin carga, sin lastre, con pluma y altura máxima · Sem carga, sem lastro, lança máxima, altura máxima · Без груза, без балласта, на макс. Длине вспомогательной стрелы и макс. Высоте



Counterweight · Zavorra controbraccio · Gegengewicht · Lest de contre-flèche · Lastre de contra flecha · Contrapeso · Противовес

C25

EN 14439-C25 · EN 14439 - C25 · EN14439 - C25 · EN 14439 - C25 · EN 14439 - C25 · EN 14439 - C25 · EN14439 - C25

CONTENTS

СТТ 561А-32

Indice · Inhalt · Contenu · Contenido · Sumário · Содержание

Page · Pagina · Seite · Page · Página · Página · Страница:

Load Diagram · Diagramma di portata · Lastkurven · Courbes de charges · Curvas de cargas · Diagrama de carga · Диаграмма грузоподъёмности	4
Tower · Torre · Turm · Tour · Torre · Torre · Башня	6
Mechanisms · Meccanismi · Antriebe · Mécanismes · Mecanismos · Mecanismo · Механизм	9
Transportation · Trasporto · Transport · Transport · Transporte · Transporte · Транспортировка	11

LOAD DIAGRAM

Diagramma di portata · Lastkurven · Courbes de charges · Curvas de cargas · Diagrama de carga · Диаграмма грузоподъёмности

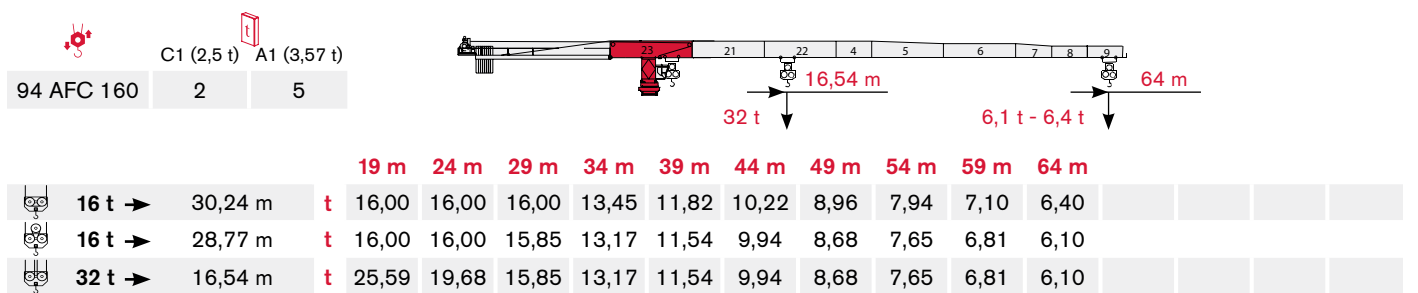
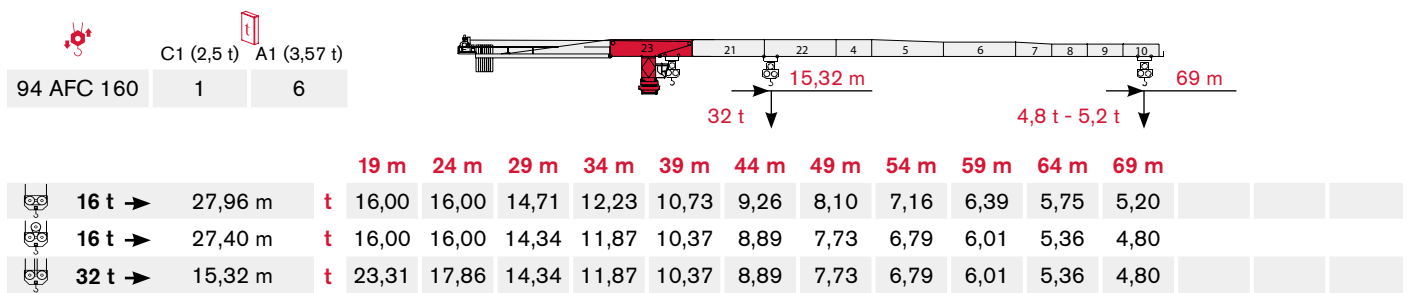
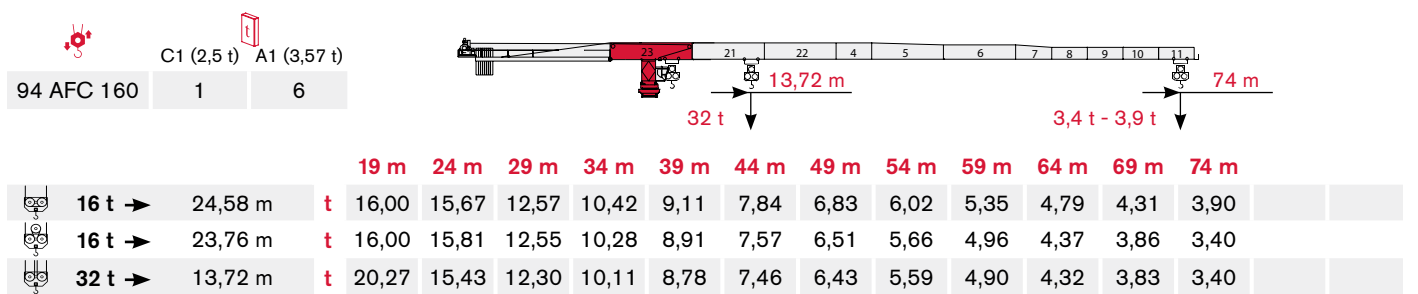
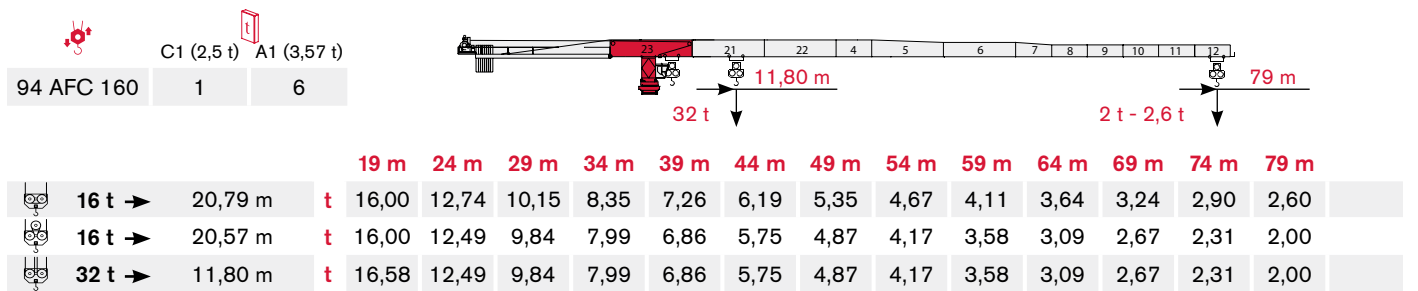
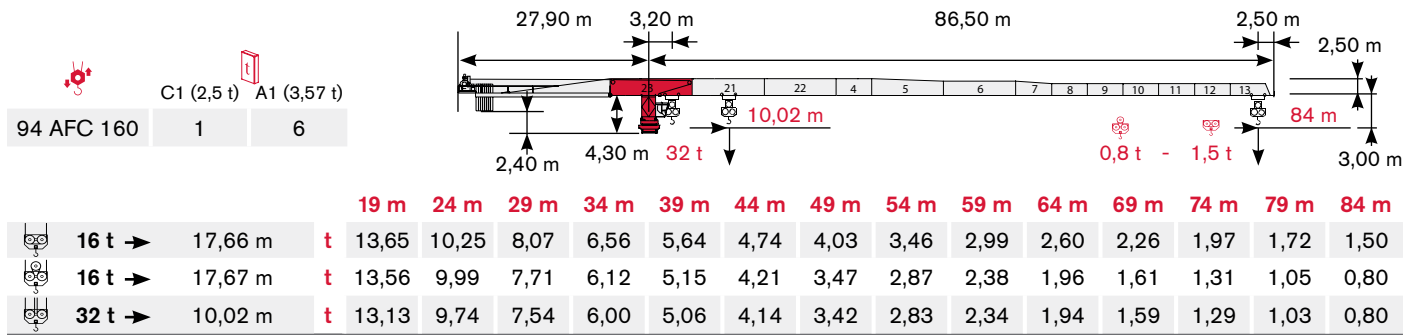

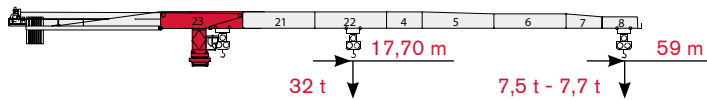

 C1 (2,5 t) A1 (3,57 t)
 94 AFC 160 3 4



			19 m	24 m	29 m	34 m	39 m	44 m	49 m	54 m	59 m				
	16 t →	32,17 m	t	16,00	16,00	16,00	14,49	12,74	11,03	9,68	8,60	7,70			
	16 t →	31,97 m	t	16,00	16,00	16,00	14,36	12,61	10,88	9,51	8,41	7,50			
	32 t →	17,70 m	t	27,75	21,38	17,25	14,36	12,61	10,88	9,51	8,41	7,50			

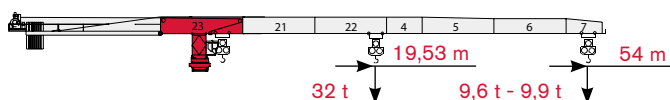



 C1 (2,5 t) A1 (3,57 t)
 94 AFC 160 0 6

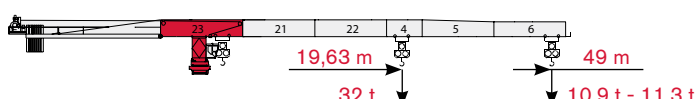

			19 m	24 m	29 m	34 m	39 m	44 m	49 m	54 m				
	16 t →	36,02 m	t	16,00	16,00	16,00	16,00	14,58	12,65	11,13	9,90			
	16 t →	35,42 m	t	16,00	16,00	16,00	16,00	14,27	12,35	10,83	9,60			
	32 t →	18,53 m	t	31,14	24,04	19,45	16,23	14,27	12,35	10,83	9,60			



 C1 (2,5 t) A1 (3,57 t)
 94 AFC 160 2 4

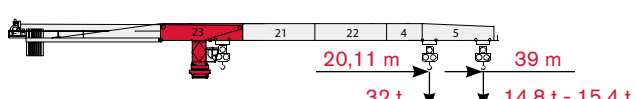

			19 m	24 m	29 m	34 m	39 m	44 m	49 m				
	16 t →	36,48 m	t	16,00	16,00	16,00	16,00	14,80	12,84	11,30			
	16 t →	35,61 m	t	16,00	16,00	16,00	16,00	14,36	12,43	10,90			
	32 t →	18,63 m	t	31,32	24,19	19,56	16,33	14,36	12,43	10,90			

 C1 (2,5 t) A1 (3,57 t)
 94 AFC 160 2 3



			19 m	24 m	29 m	34 m	39 m				
	16 t →	37,74 m	t	16,00	16,00	16,00	16,00	15,40			
	16 t →	36,51 m	t	16,00	16,00	16,00	16,00	14,80			
	32 t →	20,11 m	t	32,00	24,89	20,14	16,82	14,80			

TOWER

Torre · Turm · Tour · Torre · Torre · Башня

Standard Configurations · Installazioni Standard · Standardkonfiguration · Standard Implantations · Implantaciones Standard · Configuração padrão · Стандартная конфигурация крана

HD23

Tower: HD23 & Basement: R1

	●	◊
R1	-3763 kN	-4123 kN
R2	2872 kN	3451 kN
	1160 kN	

Tower: HD23 & Basement: FP1

	●	◊
R1	-1873 kN	-1573 kN
R2	0 kN	0 kN
	1330 kN	

Tower: HD23 & Basement: T1

	●	◊
R1	-1873 kN	-1373 kN
R2	0 kN	0 kN
	1330 kN	

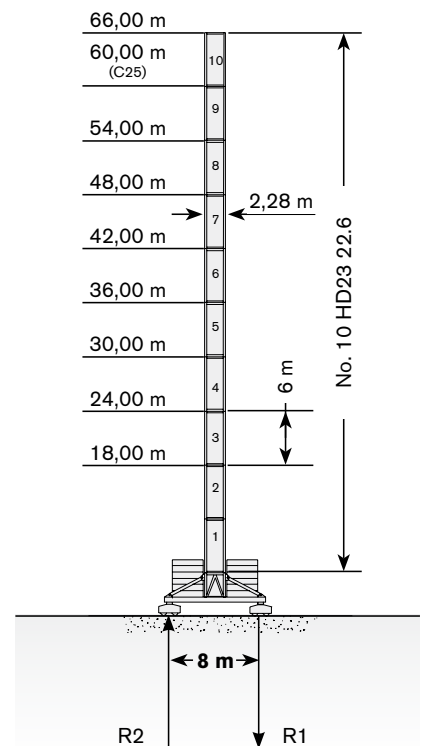
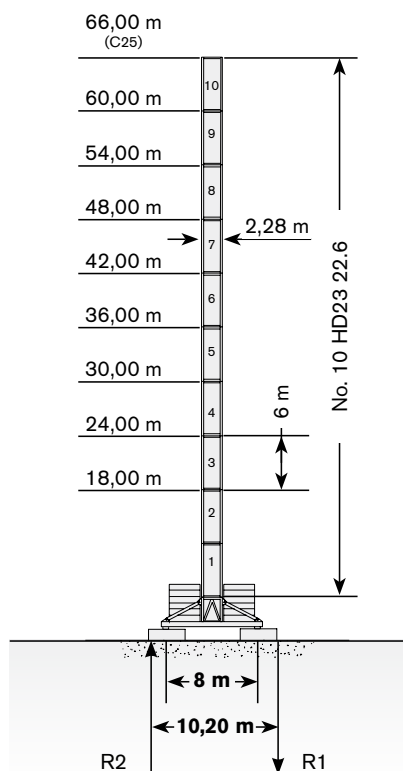
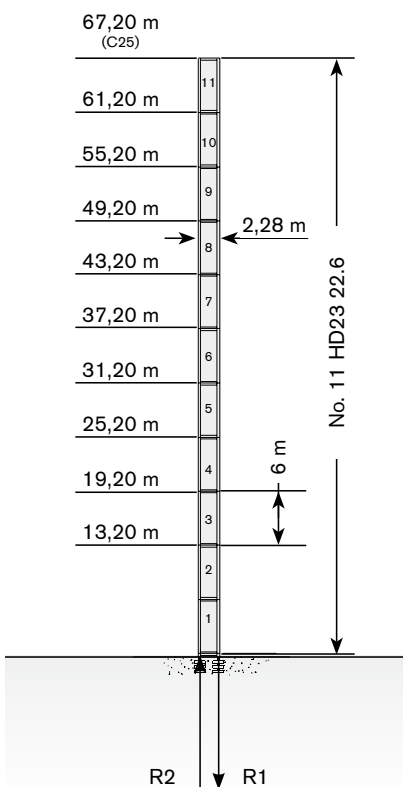

Max. under hook height · Altezza max. sotto gancio · Höchste Hakenhöhe · Hauteur maxi. sous crochet · Maxima altura bajo gancho · Alt. máx. sob o gancho · Макс высота крюка

Different heights and tower combinations are available; please consult us · Altezze diverse e combinazioni di torre sono disponibili; consultateci · Andere Höhen und Turmkombinationen auf Anfrage · Différentes hauteurs et combinaisons de tour sont disponibles; nous consulter · Hay diferentes alturas y combinaciones de torre disponibles. Consultémos · Diferentes alturas e combinações de torres disponíveis; fale conosco · Возможны другие сочетания высоты и конфигурации башни; проконсультируйтесь с нами

Tower: HD23 & Basement: R2

	●	◊
R1	-4743 kN	-5546 kN
R2	3745 kN	4772 kN
	1370 kN	

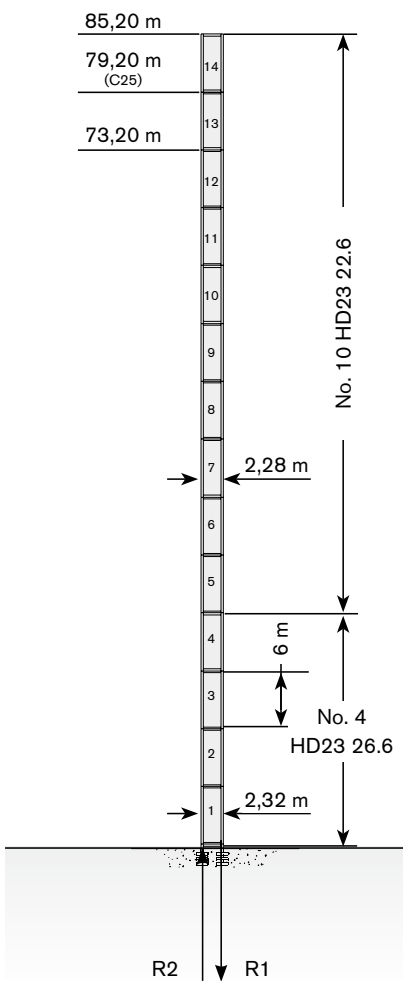

Tower: HD23 & Basement: FP6

	●	◊
R1	-1713 kN	-1870 kN
R2	0 kN	0 kN
	1620 kN	

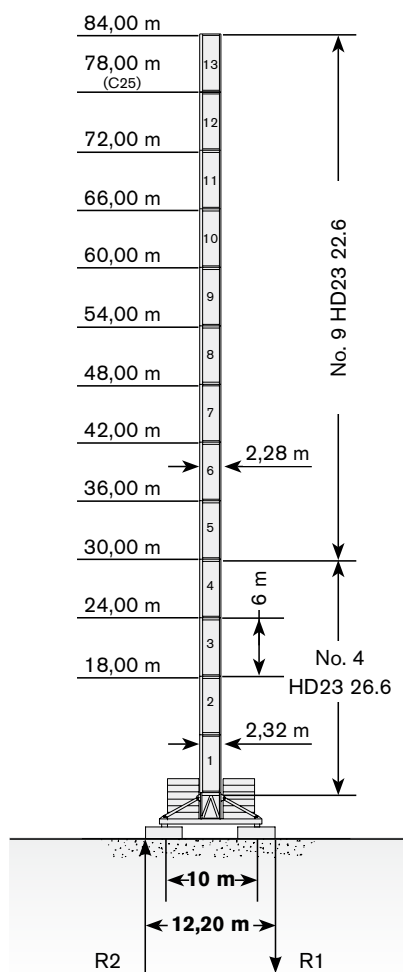

Tower: HD23 & Basement: T6

	●	◊
R1	-1908 kN	-1870 kN
R2	0 kN	0 kN
	1570 kN	

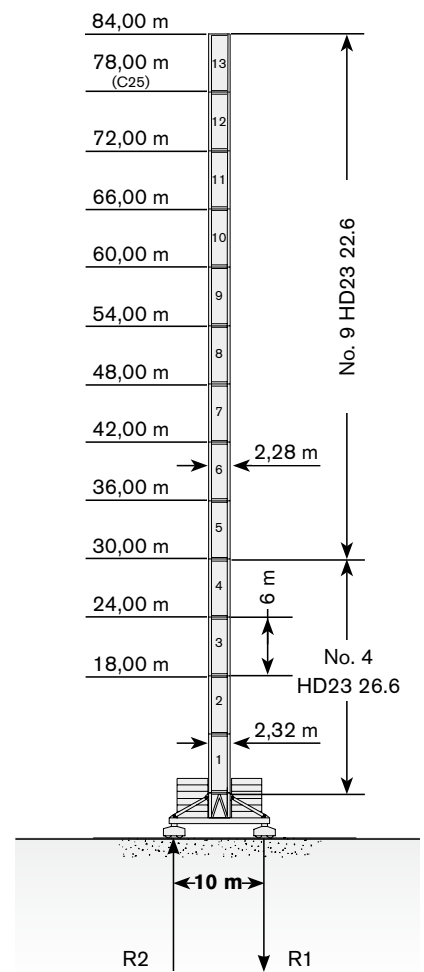

Modular base chassis is also available; please consult us · E' anche disponibile il carro modulare; consultateci · Modulares Fundamentkreuz auf Anfrage · Châssis modifiable est disponible; nous consulter · La base modular está disponible. Consultémos · A base modular está disponible; fale conosco · Модульная база доступна. проконсультируйтесь с нами

TOWER

Torre · Turm · Tour · Torre · Torre · Башня

Other configurations · Altre Installazioni · Aufstellmöglichkeiten · Autres Implantations · Otras Implantaciones · Outras configurações · Другие конфигурации

Bottom climbing crane · Gru climbing · Kletterkran im Gebäude ·
Télescopage sur dalles · Telescopage grúa trepadora · Guindaste
automontante interno · Самоподъемный кран

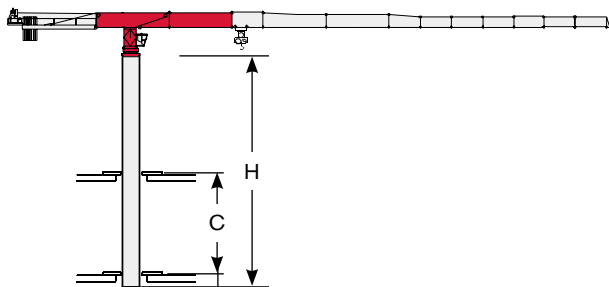

Crane tied to the structure · Gru ancorata · Geankerter Kran ·
Grue ancrée · Grúa anclada · Guindaste ancorado na estrutura ·
Кран, крепящийся к сооружению

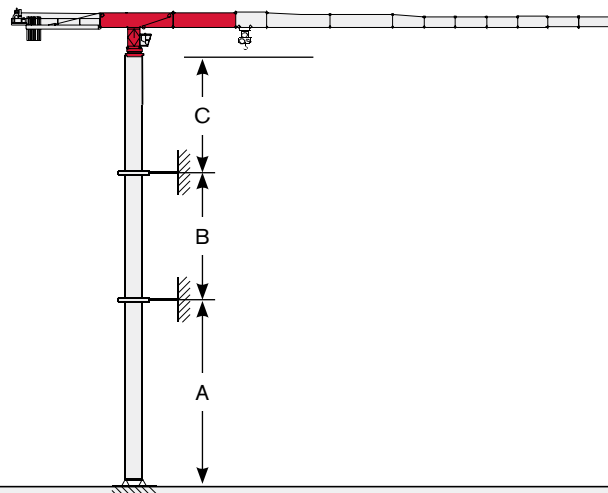

Tower: HD23-22

C min	H max
12 m	30 m
14 m	36 m
16 m	42 m

Tower: HD23 & Basement: R1

	min	max
A	36 m	54 m
B	30 m	36 m
C	42 m	

Tower: HD23 & Basement: R2

	min	max
A	36 m	66 m
B	30 m	36 m
C	42 m	

MECHANISMS

CTT 561A-32







Meccanismi · Antriebe · Mécanismes · Mecanismos · Mecanismo · Механизм

Power supply · Alimentazione · Stromversorgung · Alimentation · Suministro eléctrico · Requisitos de energia · Требования по питанию

	94 AFC 160			
	94 AFC 160	196 kVA*	400V - 50Hz / 460V - 60Hz	2000/14/CE modificata

* Crane without travelling equipment – Three movements simultaneous at 90% · Gru senza traslazione – Tre movimenti contemporanei al 90% · Krane ohne Schienenfahren – Drei gleichzeitige Bewegungen mit 90% · Grue sans translation – Trois mouvements simultanés à 90% · Grúa sin traslación – Tres movimientos contemporáneos hechos al 90% · Grua sem translação - Três movimentos simultâneos a 90% · Стационарный кран - Одновременное движение в трех направлениях на 90% мощности крана.

Hoisting · Sollevamento · Heben · Levage · Elevación · Elevação · Подъем

	94 AFC 160		t	m/min		kW	
	94 AFC 160		16	0 → 25	1°	94	478 m
			6	0 → 63			
			5,6	0 → 68	2°		
			1,5	0 → 170			
			32	0 → 13	1°		
			12	0 → 32			
			11,2	0 → 34	2°		
			3	0 → 85			

MECHANISMS

Meccanismi · Antriebe · Mécanismes · Mecanismos · Mecanismo · Механизм

Hoisting Speed · Velocità di Sollevamento · Heben Geschwindigkeit · Vitesse de Levage · Velocidad de Elevación · Velocidade de içamento · Скорость подъема

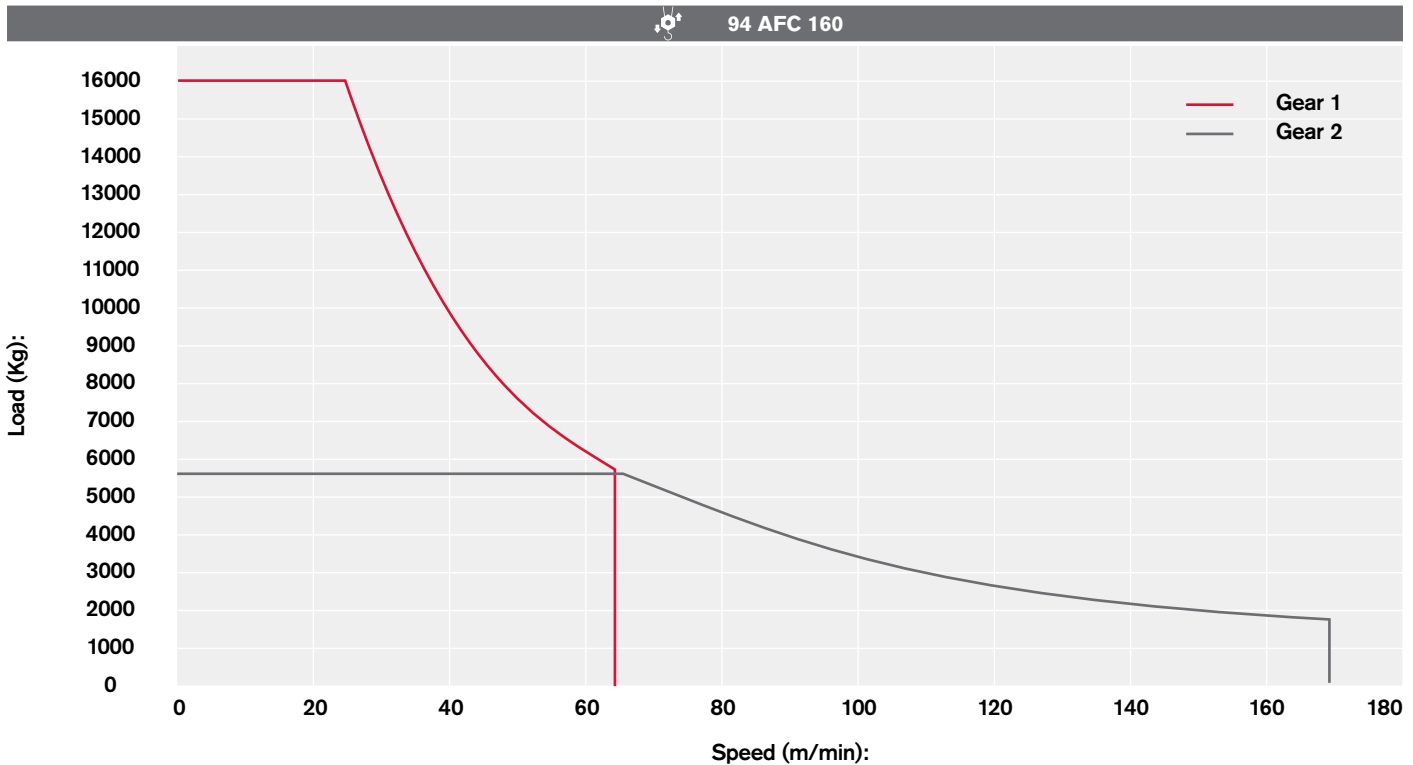

Additional Specifications · Altre movimentazioni · Weitere Leistungsdaten · Spécifications additionnelles · Otras prestaciones · Especificações adicionais · Дополнительные спецификации

	DVF 5 15	0 → 100 m/min	15 kW
	SSR 4 4 80	0,73 r.p.m.	4 x 80 Nm
	TVF 2RG 4M9 D1	0 → 24 m/min	4 x 9 kw
	TSR 2RG 4M8	12 → 24 m/min (50 Hz) 14 → 28 m/min (60 Hz)	4 x 80 Nm
	TSR 4RG 4M8	12 → 24 m/min (50 Hz) 14 → 28 m/min (60 Hz)	4 x 80 Nm



Tower height max.

		T1	T6
	TVF 2RG 4M9 D1	47,10 m	47,10 m
	TSR 2RG 4M8	47,10 m	47,10 m
	TSR 4RG 4M8	> 47,10 m	> 47,10 m











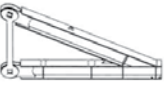

TRANSPORTATION

CTT 561A-32

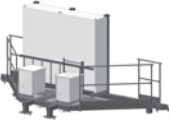
Trasporto · Transport · Transport · Transporte · Transporte · Транспортировка

Packing list

Undercarriage

CTT 561A -32 HD23	DESCRIPTION · DESCRIZIONE · BESCHREIBUNG · DESCRIPTION · DESCRIPCIÓN · DESCRIÇÃO · ОПИСАНИЕ	LENGTH · LUNGHEZZA · LÄNGE · LONGUEUR · LONGITUD · COMPRIMENTO · ДЛИНА	WIDTH · LARGHEZZA · BREITE · LARGEUR · ANCHURA · LARGURA · ШИРИНА	HEIGHT · ALTEZZA · HÖHE · HAUTEUR · ALTURA · АЛТУРА · ВЫСОТА	QUANTITY · QUANTITÀ · MENGE · QUANTITÉ · · CANTIDAD · QUANTIDADE · КОЛИЧЕСТВО	WEIGHT · PESO · GEWICHT · POIDS · PESO · PESO · ВЕС
	8×8 m UNDERCARRIAGE STRUT MOUNTING TOWER SECTION	2,90 m	2,90 m	2,90 m	1	9150 kg
	8×8 m UNDERCARRIAGE STRUT	4,30 m	0,30 m	2,25 m	4	1820 kg
	8×8 m UNDERCARRIAGE INTERNAL BEAM	4,00 m	0,16 m	0,33 m	4	210 kg
	8×8 m UNDERCARRIAGE EXTERNAL BEAM	5,96m	0,30 m	0,33 m	4	626 kg
	10×10 m UNDERCARRIAGE STRUT MOUNTING TOWER SECTION	3,00m	3,00 m	3,10 m	1	10450 kg
	10×10 m LEFT + RIGHT UNDERCARRIAGE STRUT	5,70 m	2,60 m	0,70 m	2 left + 2 right	3825 kg
	CROSSBEAM FOR TRAVELLING 10×10 m UNDERCARRIAGE	7,00 m	2,20 m	0,40 m	2	2030 kg
	10×10 m UNDERCARRIAGE ELECTRICAL BOX SUPPORT PLATFORM FOR TVF 4RT 4M9 TRAVELLING DRIVE UNIT	5,70 m	2,20 m	2,40 m	1	1300 kg
	10×10 m UNDERCARRIAGE ELECTRICAL BOX SUPPORT PLATFORM FOR TSR 4RG 4M8 TRAVELLING DRIVE UNIT	5,60 m	2,10 m	3,70 m	1	645 kg
	TOWER SECTION HD23 26.6	6,00 m	2,43 m	2,32 m	1	6473 kg*
	TOWER SECTION HD23 22.6	6,00 m	2,28 m	2,29 m	1	4823 kg*
	TOWER SECTION HD23 22.3	3,00 m	2,29 m	2,28 m	1	2550 kg*
	SLEWING UNIT	2,96 m	2,32 m	2,24 m	1	11500 kg

* inclusive of ladders, platforms and assembly equipment

** inclusive of tie-bars and safety rails

*** inclusive of trolley winch and accessories

**** ballast plates not included

TRANSPORTATION

Trasporto · Transport · Transport · Transporte · Transporte · Транспортировка





CTT 561A -32 HD23	DESCRIPTION · DESCRIZIONE · BESCHREIBUNG · DESCRIPTION · DESCRIPCIÓN · DESCRIÇÃO · ОПИСАНИЕ	LENGTH · LUNGHEZZA · LÄNGE · LONGUEUR · LONGITUD · COMPRIENTO · ДЛИНА	WIDTH · LARGHEZZA · BREITE · LARGEUR · ANCHURA · LARGURA · ШИРИНА	HEIGHT · ALTEZZA · HÖHE · HAUTEUR · ALTURA · ALTEURA · ВЫСОТА	QUANTITY · QUANTITÀ · MENGE · QUANTITÉ · CANTIDAD · QUANTIDADE · КОЛИЧЕСТВО	WEIGHT · PESO · GEWICHT · POIDS · PESO · PESO · ВЕС
	CAB SUPPORT PLATFORM	5,54 m	1,87 m	2,69 m	1	2000 kg
	CAB TOWER SECTION	1,90 m	2,50 m	3,23 m	1	3050 kg
	COUNTERJIB "1C"	7,16 m	1,99 m	0,86 m	1	3950 kg**
	COUNTERJIB "3C"	11,66 m	2,21 m	1,10 m	1	5800 kg**
	JIB SECTION-23 23TT19 23.12	12,00 m	2,54 m	2,54 m	1	11000 kg***
	JIB TROLLEY 20-24 t	2,38 m	2,29 m	1,45 m	1	765 kg
	JIB SECTION-21 21TT19 23.10	10,29 m	1,87 m	2,54 m	1	4900 kg
	JIB SECTION-22 22TT19 23.10	10,34 m	1,87 m	2,50 m	1	4000 kg
	JIB SECTION-04 TT19 23.05	5,00 m	1,87 m	2,50 m	1	1800 kg
	JIB SECTION-05 TT19 23.10	10,00 m	1,87 m	2,50 m	1	2700 kg
	JIB SECTION-06 TT19 20.10	10,29 m	1,87 m	2,18 m	1	1930 kg
	JIB SECTION-07 TT1920.05	5,28 m	1,87 m	2,18 m	1	900 kg
	JIB SECTION-08 TT1917.05	5,25 m	1,87 m	1,86 m	1	780 kg

* inclusive of ladders, platforms and assembly equipment

** inclusive of tie-bars and safety rails

*** inclusive of trolley winch and accessories

**** ballast plates not included

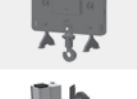
CTT 561A -32 HD23	DESCRIPTION · DESCRIZIONE · BESCHREIBUNG · DESCRIPTION · DESCRIPCIÓN · DESCRIÇÃO · ОПИСАНИЕ	LENGTH · LUNGHEZZA · LÄNGE · LONGUEUR · LONGITUD · COMPRIMENTO · ДЛИНА	WIDTH · LARGHEZZA · BREITE · LARGEUR · ANCHURA · LARGURA · ШИРИНА	HEIGHT · ALTEZZA · HÖHE · HAUTEUR · ALTURA · ALTURA · ВЫСОТА	QUANTITY · QUANTITÀ · MENGE · QUANTITÉ · · CANTIDAD · QUANTIDADE · КОЛИЧЕСТВО	WEIGHT · PESO · GEWICHT · POIDS · PESO · PESO · ВЕС
	JIB SECTION-09 TT1917.05	5,22 m	1,87 m	1,86 m	1	940 kg
	JIB SECTION-10 TT1917.05	5,19 m	1,87 m	1,86 m	1	520 kg
	JIB SECTION-11 TT1917.05	5,16 m	1,87 m	1,86 m	1	452 kg
	JIB SECTION-12 TT1917.05	5,16 m	1,87 m	1,77 m	1	380 kg
	JIB SECTION-13 TT1917.05	5,16 m	1,87 m	1,77 m	1	325 kg
	JIB POINT 20/24 t	2,13 m	1,18 m	1,61 m	1	270 kg
	FALLS LINE HOIST BLOCK 20-24 t	1,59 m	0,60 m	1,65 m	1	845 kg****
	HOIST WINCH 94 AFC 160-200 D2 (VECTOR 2) (without rope)	4,56 m	2,55 m	2,51 m	1	7250 kg

TEREX TOWER CRANES

Gru Comedil Srl

Via delle Innovazioni, 17
33074 Fontanafredda (PN)
Italy
Ph: +39 0434 989111
Email: mktg.cranes@terex.com

March 2024. Product specifications and prices are subject to change without notice or obligation. The photographs and/or drawings in this document are for illustrative purposes only. Refer to the appropriate Operator's Manual for instructions on the proper use of this equipment. Failure to follow the corresponding Operator's Manual when using our equipment or to otherwise act responsibly may result in serious injury or death. The only warranty applicable to our equipment is the standard written warranty applicable to the particular product and sale and Terex makes no other warranty, express or implied. Products and services listed may be trademarks, service marks or trade-names of Terex Corporation and/or its subsidiaries in the USA and other countries. All rights are reserved. Terex, the Terex Crown design and Works For You are trademarks of Terex Corporation or its subsidiaries.

Marzo 2024. Specifiche e prezzi dei prodotti sono soggetti a modifica senza preavviso o altro obbligo. Le fotografie e i disegni in questo documento hanno esclusivamente scopo illustrativo. Consulta il Manuale dell'operatore pertinente per trovare istruzioni per l'utilizzo corretto di questo macchinario. La mancata osservanza delle istruzioni contenute nel relativo Manuale dell'operatore durante l'uso del macchinario e altri comportamenti irresponsabili possono provocare gravi lesioni, anche mortali. L'unica garanzia applicabile ai nostri macchinari è la garanzia scritta standard applicabile al particolare prodotto e alla particolare vendita e Terex è esonerata dal fornire qualsiasi altra garanzia, esplicita o implicita. I prodotti e servizi elencati possono essere dei marchi di fabbrica, marchi di servizio o nomi commerciali di Terex Corporation, e/o delle rispettive società affiliate negli Stati Uniti d'America e in molte altre nazioni. Tutti i diritti riservati. Terex, il marchio Terex Crown e Works for You sono marchi di proprietà di Terex Corporation o delle sue società affiliate.

März 2024. Irrtum und Änderungen der Produktspezifikationen vorbehalten. Die in diesem Dokument enthaltenen Fotos und/oder Zeichnungen dienen rein anschaulichen Zwecken. Für den sachgemäßen Gebrauch der Maschinen ist das entsprechende Bedienerhandbuch heranzuziehen. Unsachgemäßer Umgang mit bzw. unsachgemäßer Einsatz unserer Maschinen kann zu schweren gesundheitlichen Schäden bis hin zum Tod führen. Für unsere Produkte wird ausschließlich die entsprechende, schriftlich niedergelegte Standardgarantie gewährt. Terex leistet keinerlei darüber hinausgehende Garantie, weder ausdrücklich noch stillschweigend. Die genannten Produkte und Dienstleistungen sind in den USA und anderen Ländern ggf. Marken, Dienstleistungsmarken oder Handelsnamen der Terex Corporation und/oder ihrer Tochtergesellschaften. Alle Rechte vorbehalten. Terex, das Terex Kronenlogo und Works For You sind Marken in Eigentum der Terex Corporation bzw. ihrer Tochtergesellschaften.

Mars 2024. Les caractéristiques et prix des produits peuvent faire l'objet de modifications sans notification préalable. Les photographies ou dessins présentés dans ce document servent uniquement à des fins d'illustration. Pour connaître les instructions relatives à l'utilisation correcte de cet équipement, veuillez vous référer au manuel de l'utilisateur correspondant. Le non-respect du manuel d'utilisateur correspondant lors de l'utilisation de notre équipement ou des actes irresponsables risquent de provoquer de graves blessures, voire un décès. La seule garantie applicable à nos équipements est la garantie écrite standard applicable au produit et à la vente spécifiques. Terex ne délivre aucune autre garantie, expresse ou implicite. Les produits et les services mentionnés peuvent être des marques, des marques de service ou des appellations commerciales de Terex Corporation et/ou de ses filiales aux États-Unis et dans d'autres pays. Tous droits réservés. Terex, le design Terex Crown et Works For You sont des marques déposées de Terex Corporation ou de ses filiales.

Marzo 2024. Las especificaciones y los precios de los productos están sujetos a cambios sin necesidad de previo aviso ni ninguna otra obligación. Las fotografías y/o dibujos de este documento tienen un fin meramente ilustrativo. Consulte el correspondiente manual de instrucciones del operario para obtener más información sobre el uso correcto de esta maquinaria. No respetar el manual del operario al utilizar la maquinaria o actuar de forma irresponsable puede provocar lesiones graves e incluso mortales. La única garantía aplicable a nuestra maquinaria es la garantía escrita estándar de cada producto y venta. Terex no amplía dicha garantía de forma expresa ni implícita. Los productos y servicios mencionados pueden ser marcas comerciales, marcas de servicio o nombres de marca de Terex Corporation o de alguna de sus filiales en Estados Unidos y otros países. Todos los derechos reservados. Terex, el diseño de la corona Terex y Works For You son marcas registradas de Terex Corporation o de sus filiales.

Março 2024. Especificações e preços dos produtos sujeitos a alteração sem aviso prévio ou obrigações. As fotografias e/ou desenhos neste documento são apenas para fins ilustrativos. Consulte o respectivo Manual do Operador para instruções sobre o uso correto deste equipamento. Deixar de acompanhar o respectivo Manual do Operador ao usar o nosso equipamento ou, por qualquer outra forma, deixar de agir de maneira responsável pode resultar em lesões corporais graves ou a morte. A única garantia aplicável ao nosso equipamento é a garantia padrão por escrito correspondente ao produto específico vendido. A Terex não dá outras garantias, expressas ou implícitas. Os produtos e serviços listados podem ser marcas comerciais, marcas de serviço ou nomes-fantasia da Terex Corporation e/ou suas subsidiárias nos EUA e em outros países. Todos os direitos reservados. Terex, o desenho da Coroa Terex e a expressão Works For You são marcas comerciais da Terex Corporation ou suas subsidiárias.

Март 2024 г. года Технические характеристики и цены могут изменяться без предварительного уведомления и без каких-либо обязательств для производителя. Фотографии и (или) чертежи в настоящем документе служат только в качестве иллюстраций. Инструкции по надлежащей эксплуатации данного оборудования см. в соответствующем руководстве для оператора. Невыполнение указаний соответствующих руководств для оператора при эксплуатации оборудования или другие безответственные действия могут повлечь серьезные травмы или смерть. Единственной гарантией, действующей в отношении нашего оборудования, является стандартная форма письменной гарантии на данный тип оборудования и на условия его продажи. Терех не дает никаких других гарантий: ни ясно выраженных, ни подразумеваемых. Перечисленные продукты и услуги могут быть торговыми марками, знаками обслуживания или торговыми наименованиями Terex Corporation и / или ее дочерних компаний в США и других странах. Все права защищены. Терех, изображение короны Terex и Works for You являются торговыми марками, принадлежащими корпорации Терех или ее дочерним компаниям.



www.terex.com/tower-cranes

Brochure Reference: TC-DS-M-E//G/F/S/P/R-CTT561A-32-03/24



WORKS FOR YOU.™