

FLAT TOP TOWER CRANE

Specifications:

- ▶ Max jib length: 85,00 m
- ▶ Capacity at max length: 4,65 t
- ▶ Max capacity: 40 t

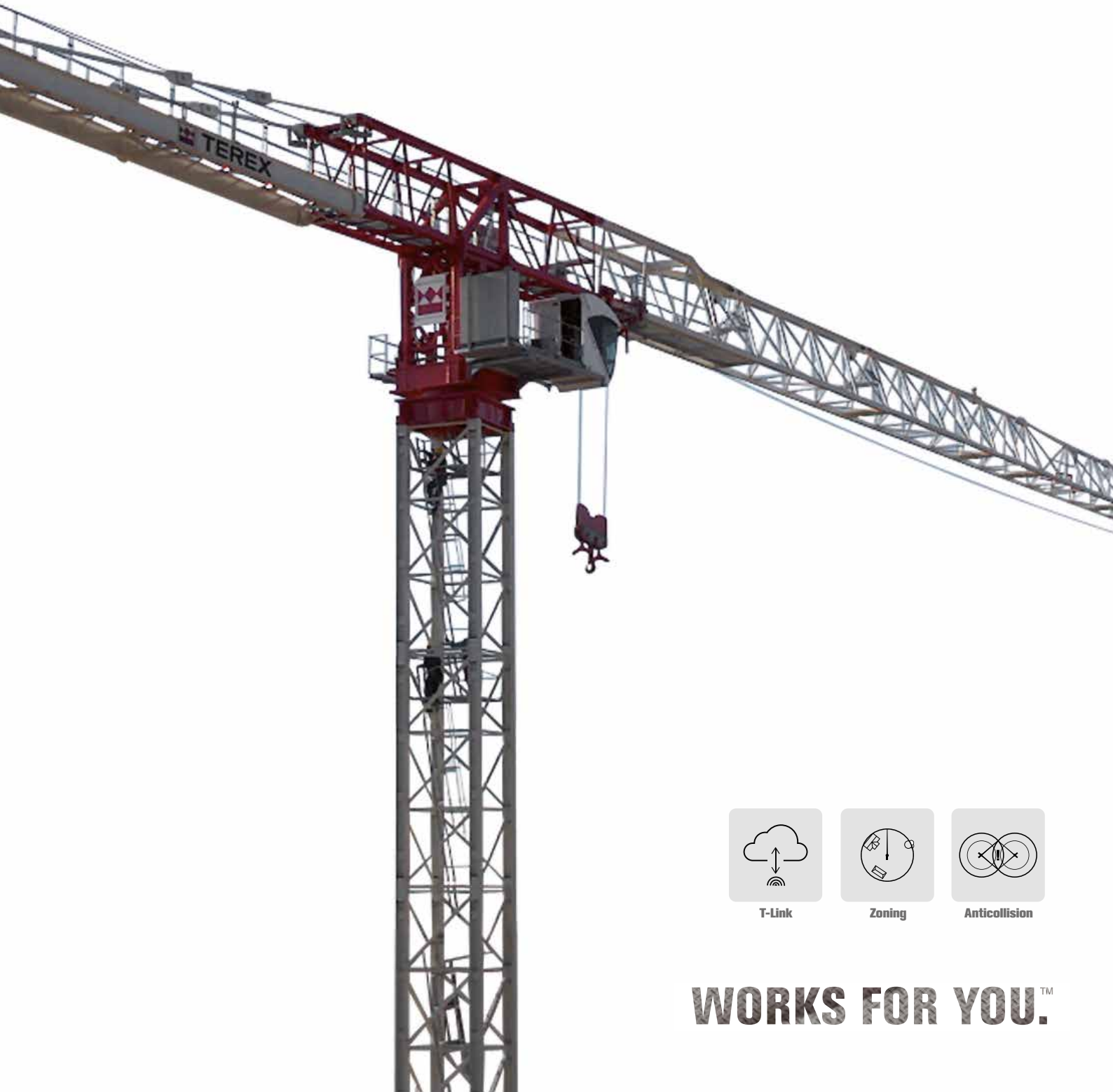

T-Link



Zoning

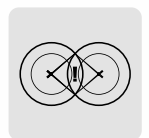

Anticollision

WORKS FOR YOU.™

KEY

Zeichenerklärung · Légende · Leyenda · Legenda · Legenda · Условные обозначения



Hoisting · Heben · Levage · Elevación · Sollevamento · Elevação · Подъем



Trolleying · Katzfahren · Distribution · Distribución · Traslazione carrello · Distribuição · Передвижение каретки



Slewing · Schwenken · Orientation · Orientació · Rotazione · Giro · Поворот



Travelling · Schienenfahren · Translation · Traslación · Traslazione · Móvel · Передвижение



Directive on noise level · Richtlinie für den Schall-Leistungspegel · Directive sur le niveau acoustique · Directiva sobre el nivel acustico · Direttiva sul livello acustico · Diretiva sobre nível de ruídos · Директива по уровню шума



Consult us · Auf Anfrage · Nous consulter · Consultarnos · Consultateci · Consulte-nos · Проконсультироваться с нами



Power requirements · Geforderte Stromstärke · Puissance totale nécessaire · Potencia necesaria · Potenza totale richiesta · Requisitos de energia · Требования по питанию



Power supply · Stromversorgung · Alimentation · Alimentación · Alimentazione · Fonte de alimentação · Питание



In service · In Betrieb · En service · En servicio · In servizio · Em serviço · При работе



Out of service · Außer Betrieb · Hors service · Fuera de servicio · Fuori servizio · Fora de serviço · В режиме простоя



Max. under hook height · Höchste Hakenhöhe · Hauteur maxi. sous crochet · Maxima altura bajo gancho · Altezza max. sottogancio · Alt. máx. sob o gancho · Макс высота крюка



Without load, without ballast, max. jib and max. height · Ohne Last und Ballast, mit Maximalausleger und Maximalhöhe · A vide, sans lest, avec flèche et hauteur maximum · Sin carga, sin lastre, con pluma y altura máxima · A vuoto, senza zavorra, braccio max., altezza max. · Sem carga, sem lastro, lança máxima, altura máxima · Без груза, без балласта, на макс. Длине вспомогательной стрелы и макс. Высоте



Counterweight · Gegengewicht · Lest de contre-flèche · Lastre de contra flecha · Zavorra controbraccio · Contrapeso · Противовес

C25

EN 14439-C25 out of service proof with LC1 & LC3 - wind coming from each side 100 Km/h - For different requirement please contact us · EN 14439 - C25 außer Betrieb mit LC1 & LC3 - Wind von jeder Seite 100 km/h - für abweichende Anforderungen kontaktieren Sie uns bitte · EN14439 - C25 hors service avec LC1 & LC3 - vent 100km/h de chaque côté - Nous contacter pour des caractéristiques différentes · EN 14439 - C25 fuera de servicio con LC1 & LC3 - viento de cada lado 100 km/h - contáctenos si necesita más información · EN 14439 - C25 fuori servizio con LC1 & LC 3 - vento in ogni direzione 100 km/h - contattateci per differenti richieste · EN 14439 - C25 fora de serviço com LC1 e LC3 - vento de cada lado 100 kmh - para pedidos especiais, entre em contato conosco · EN14439 - C25 не совместим с LC1 & LC3 - ветровая нагрузка не более 100км/ч - для уточнения спецификаций обращайтесь, пожалуйста, к нам

CONTENTS

СТТ 721В-40

Inhalt · Contenu · Contenido · Indice · Sumário · Содержание

Page · Seite · Page · Página · Pagina · Página · Страница:

Load Diagram · Lastkurven · Courbes de charges · Curvas de cargas · Diagramma di portata · Diagrama de carga · Диаграмма грузоподъёмности	4
Tower · Turm · Tour · Torre · Torre · Torre · Башня	6
Mechanisms · Antriebe · Mécanismes · Mecanismos · Meccanismi · Mecanismo · Механизм	8
Transportation · Transport · Transport · Transporte · Trasporto · Transporte · Транспортировка	9

LOAD DIAGRAM

CTT 721B-40

Lastkurven · Courbes de charges · Curvas de cargas · Diagramma di portata · Diagrama de carga · Диаграмма грузоподъёмности

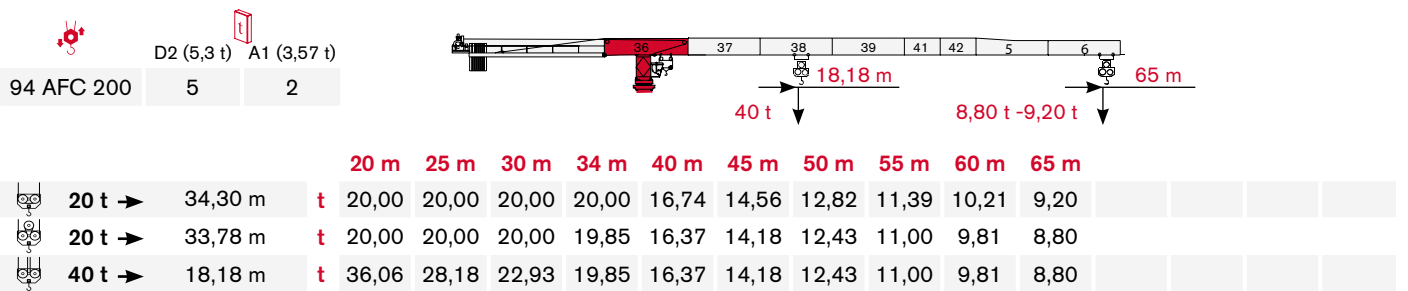
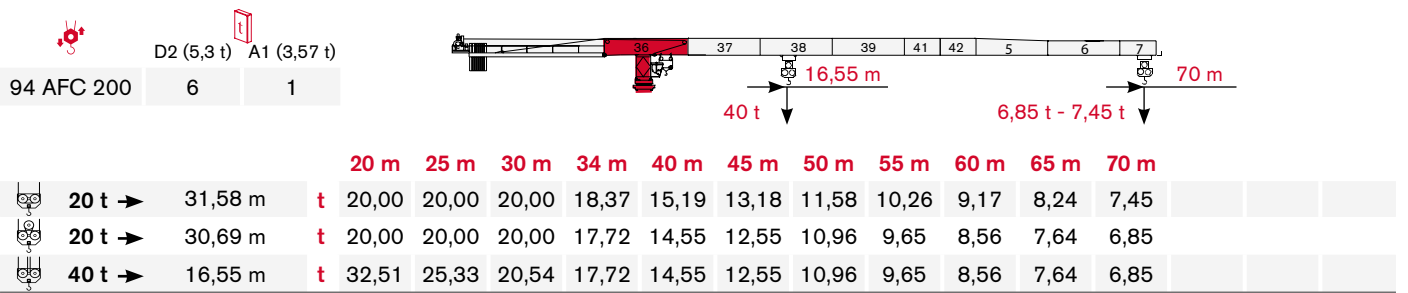
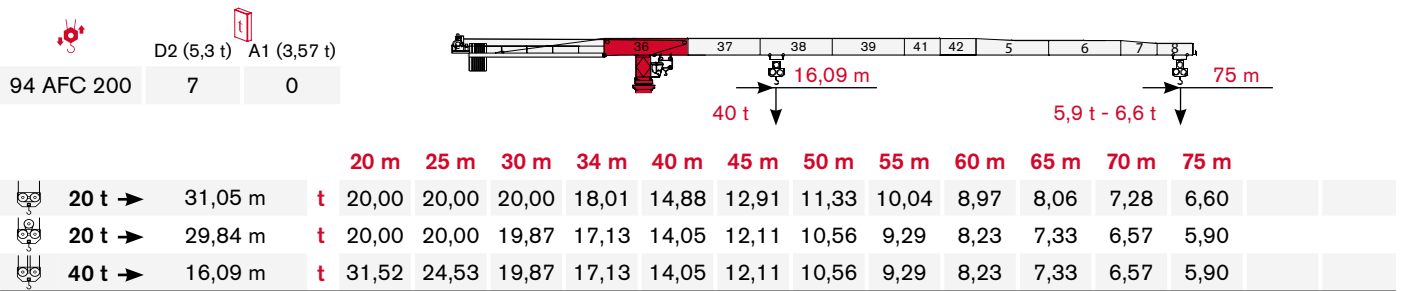
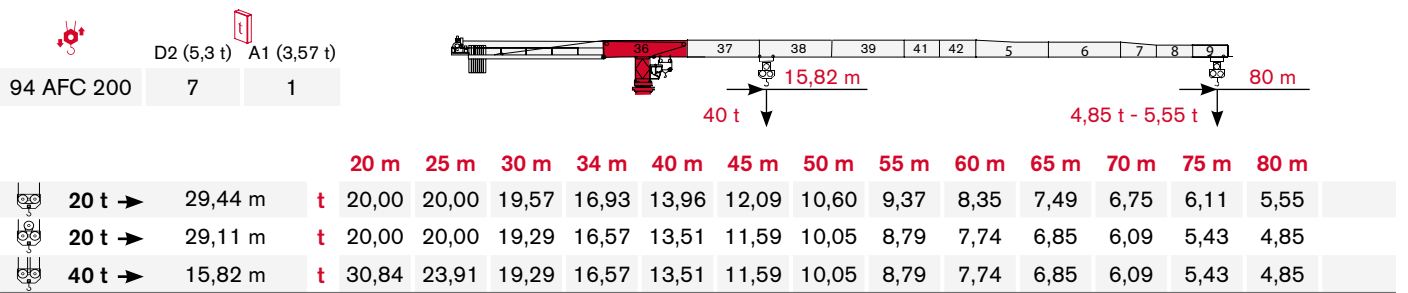
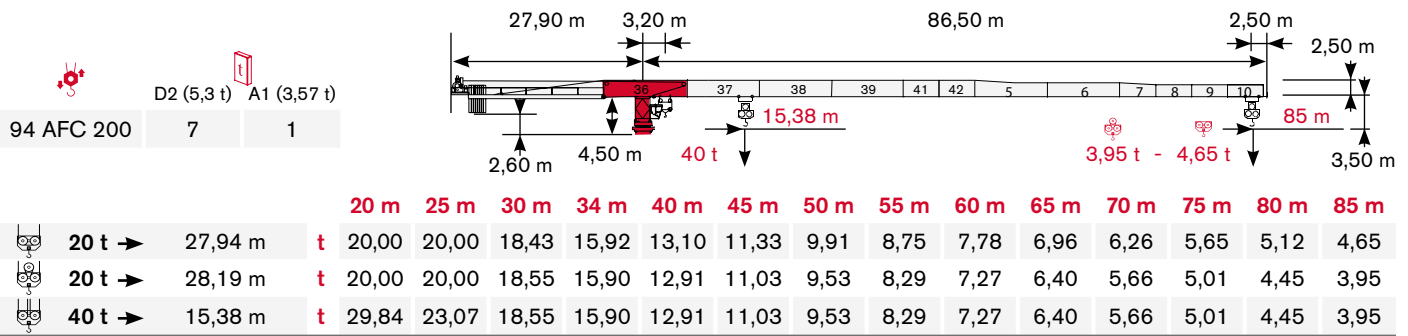

94 AFC 200 D2 (5,3 t) A1 (3,57 t)
5 1

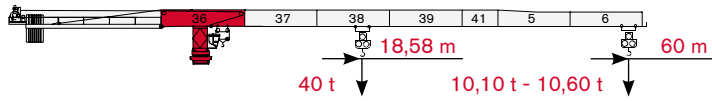

			20 m	25 m	30 m	34 m	40 m	45 m	50 m	55 m	60 m
20 t →	35,33 m	t	20,00	20,00	20,00	20,00	17,33	15,09	13,29	11,82	10,60
20 t →	34,52 m	t	20,00	20,00	20,00	20,00	16,81	14,57	12,78	11,32	10,10
40 t →	18,58 m	t	36,93	28,88	23,51	20,36	16,81	14,57	12,78	11,32	10,10

94 AFC 200 D2 (5,3 t) A1 (3,57 t)
4 2

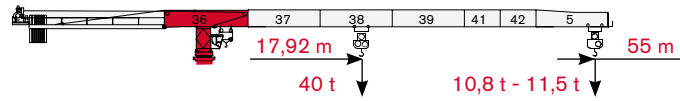

			20 m	25 m	30 m	34 m	40 m	45 m	50 m	55 m
20 t →	34,55 m	t	20,00	20,00	20,00	20,00	16,89	14,69	12,94	11,50
20 t →	33,30 m	t	20,00	20,00	20,00	19,52	16,09	13,94	12,21	10,80
40 t →	17,92 m	t	35,50	27,74	22,56	19,52	16,09	13,94	12,21	10,80

94 AFC 200 D2 (5,3 t) A1 (3,57 t)
5 0

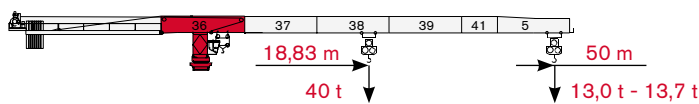

			20 m	25 m	30 m	34 m	40 m	45 m	50 m
20 t →	36,22 m	t	20,00	20,00	20,00	20,00	17,84	15,54	13,70
20 t →	34,99 m	t	20,00	20,00	20,00	20,00	17,08	14,81	13,00
40 t →	18,83 m	t	37,47	29,31	23,88	20,68	17,08	14,81	13,00

94 AFC 200 D2 (5,3 t) A1 (3,57 t)
4 1

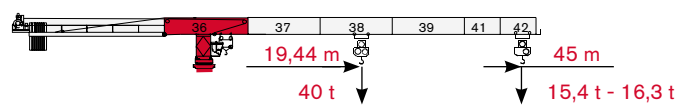

			20 m	25 m	30 m	34 m	40 m	45 m
20 t →	37,72 m	t	20,00	20,00	20,00	20,00	18,70	16,30
20 t →	36,12 m	t	20,00	20,00	20,00	20,00	17,74	15,40
40 t →	19,44 m	t	38,79	30,37	24,76	21,45	17,74	15,40

94 AFC 200 D2 (5,3 t) A1 (3,57 t)
3 2

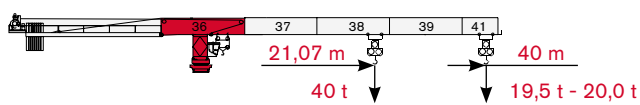

			20 m	25 m	30 m	34 m	40 m
20 t →	40,00 m	t	20,00	20,00	20,00	20,00	20,00
20 t →	40,00 m	t	20,00	20,00	20,00	20,00	20,00
40 t →	21,07 m	t	40,00	33,19	27,10	23,53	19,50

94 AFC 200 D2 (5,3 t) A1 (3,57 t)
2 3

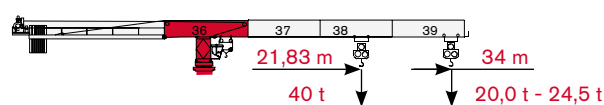

			20 m	25 m	30 m	34 m
20 t →	34,00 m	t	20,00	20,00	20,00	20,00
20 t →	34,00 m	t	20,00	20,00	20,00	20,00
40 t →	21,83 m	t	40,00	34,51	28,21	24,50

TOWER

Turm · Tour · Torre · Torre · Torre · Башня

Standard Configurations · Standardkonfiguration · Standard Implantations ·
 Implantaciones Standard · Installazioni Standard · Configuração padrão ·
 Стандартная конфигурация крана

HD23

Tower: HD23 & Basement: R2

	●	◆
R1	-3743 kN	-5255 kN
R2	2510 kN	4316 kN
	1540,65 kN	

Tower: HD23 & Basement: R3

	●	◆
R1	-5450 kN	-6185 kN
R2	4217 kN	5200 kN
	1627 kN	

Tower: HD23 & Basement:
FP6

	●	◆
R1	-1598 kN	-1823 kN
R2	-344 kN	-120 kN
	1735 kN	

Tower: HD23 & Basement: T6

	●	◆
R1	-1684 kN	-1823 kN
R2	-406 kN	-190 kN
	1735 kN	

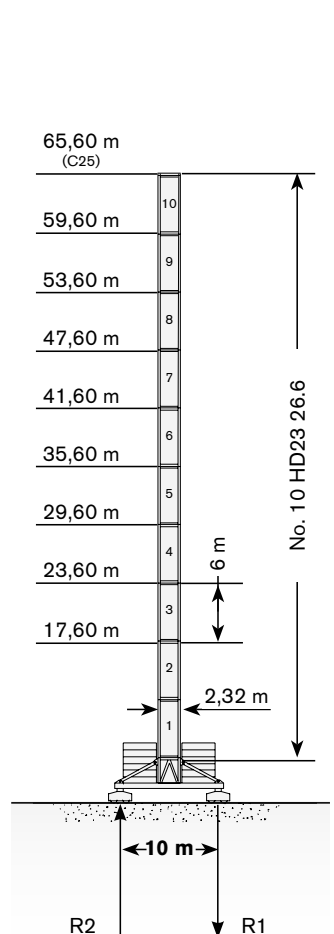
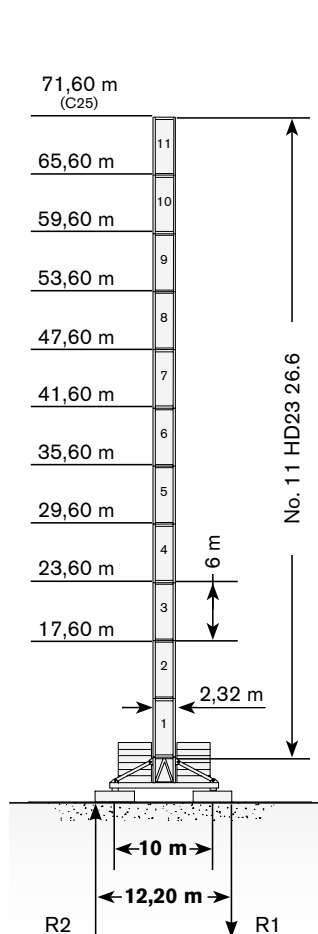
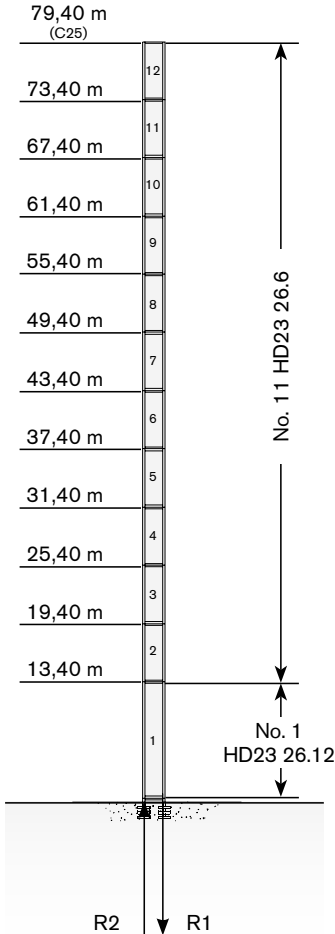
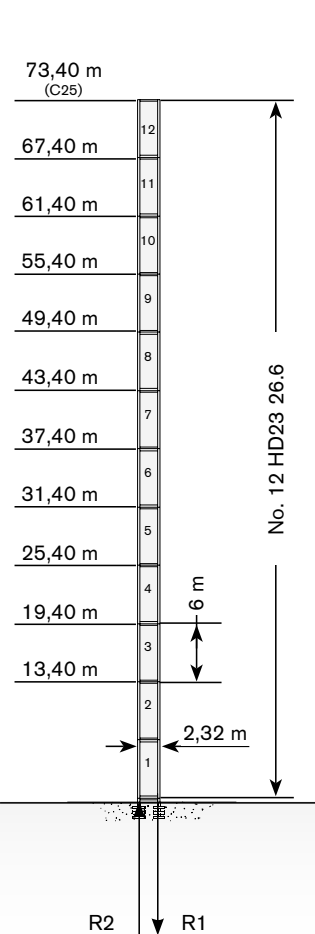

Max. under hook height · Höchst Hakenhöhe · Hauteur maxi. sous crochet · Maxima altura bajo gancho · Altezza max. sotto gancio ·
 Alt. máx. sob o gancho · Макс высота крюка

Different heights and tower combinations are available; please consult us · Andere Höhen und Turmkombinationen auf Anfrage · Différentes hauteurs et combinaisons de tour sont disponibles; nous consulter · Hay diferentes alturas y combinaciones de torre disponibles. Consúltenos · Altezze diverse e combinazioni di torre sono disponibili; consultateci · Diferentes alturas e combinações de torres disponíveis; fale conosco · Возможны другие сочетания высоты и конфигурации башни; проконсультируйтесь с нами.

Modular base chassis is also available; please consult us · E' anche disponibile il carro modulare; consultateci · Modulares Fundamentkreuz auf Anfrage · Châssis modifiable est disponible; nous consulter · La base modular está disponible. Consúltenos · A base modular está disponível; fale conosco · модульная база доступна. проконсультируйтесь с нами

Other configurations · Aufstellmöglichkeiten · Autres Implantations · Otras Implantaciones · Altre Installazioni · Outras configurações · Другие конфигурации

Bottom climbing crane · Kletterkran im Gebäude · Télescopage sur dalles · Telescopage grúa trepadora · Gru climbing · Guindaste automontante interno · Самоподъемный кран

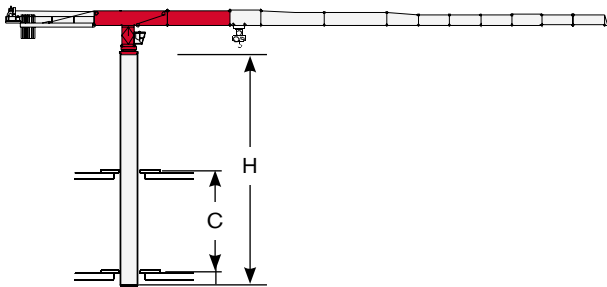

Tower: HD23-26

C min	H max
14 m	48 m
16 m	54 m
18 m	60 m
21 m	66 m

Crane tied to the structure · Geankerter Kran · Grue ancrée · Grúa anclada · Gru ancorata · Guindaste ancorado na estrutura · Кран, крепящийся к сооружению

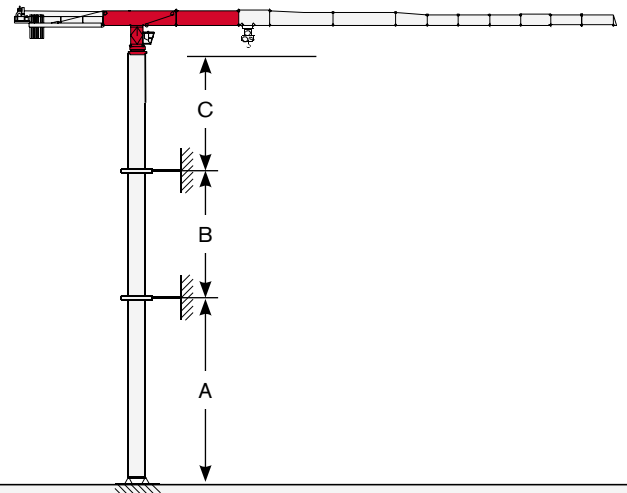

Tower: HD23-26

	min	max
A	42 m	60 m
B	30 m	36 m
C	36 m	



Different heights and tower combinations are available; please consult us · Andere Höhen und Turmkombinationen auf Anfrage · Différentes hauteurs et combinaisons de tour sont disponibles; nous consulter · Hay diferentes alturas y combinaciones de torre disponibles. Consultémos · Altezze diverse e combinazioni di torre sono disponibili; consultateci · Diferentes alturas e combinações de torres disponíveis; fale conosco · Возможны другие сочетания высоты и конфигурации башни; проконсультируйтесь с нами

MECHANISMS

Antriebe · Mécanismes · Mecanismos · Meccanismi · Mecanismo · Механизм

Power supply · Stromversorgung · Alimentation · Suministro eléctrico · Alimentazione · Requisitos de energia · Требования по питанию

	94 AFC 200	163 kVA*	400V - 50Hz / 460V - 60Hz	2000/14/CE modificata
--	------------	----------	---------------------------	-----------------------

* Average consumption · Durchschnittsverbrauch · Consommation moyenne · Consumo medio · Consumo medio · Consumo médio · Среднее потребление

Hoisting · Heben · Levage · Elevación · Sollevamento · Elevação · Подъем

			t	m/min		kW	
	94 AFC 200		20	0 → 21	1°	94	 478 m max 239 m
			7,5	0 → 52			
			6,4	0 → 58			
			2	0 → 146			
			40	0 → 11	1°		
			15	0 → 26			
			12,8	0 → 29	2°		
			4	0 → 73			

Hoisting Speed · Heben Geschwindigkeit · Vitesse de Levage · Velocidad de Elevación · Velocità di Sollevamento · Velocidade de içamento · Скорость подъема

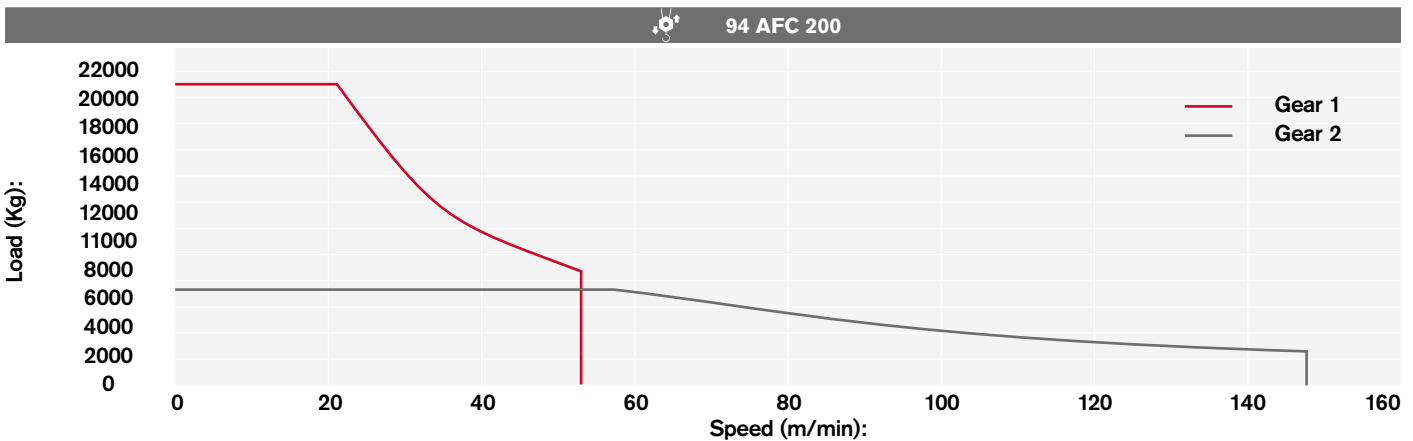

Additional Specifications · Weitere Leistungsdaten · Spécifications additionnelles · Otras prestaciones · Altre movimentazioni · Especificações adicionais · Дополнительные спецификации

	DVF 5 22	0 → 83 m/min	22 kW
	SCC 2 2 132 P	0,67 r.p.m.	2 x 18 kW
	TSR 4RG 4M8	12 → 24 m/min (50 Hz) 14 → 28 m/min (60 Hz)	4 x 80 Nm
	TVF 4RT 4M9	0 → 21 m/min	4 x 9 kW

Tower height max.

		T6
	TSR 4RG 4M8	53,60 m
	TVF 4RT 4M9	>53,60 m





TRANSPORTATION

CTT 721B-40





Transport · Transport · Transporte · Trasporto · Transporte · Транспортировка

Packing list

Undercarriage

CTT 721B-40	DESCRIPTION · BESCHREIBUNG · DESCRIPTION · DESCRIPCIÓN · DESCRIZIONE · DESCRIÇÃO · ОПИСАНИЕ	LENGTH · LÄNGE · LONGUEUR · LONGITUD · LUNGHEZZA · COMPRIMENTO · ДЛИНА	WIDTH · BREITE · LARGEUR · ANCHURA · LARGHEZZA · LARGURA · ШИРИНА	HEIGHT · HÖHE · HAUTEUR · ALTURA · ALTEZZA · ALTURA · ВЫСОТА	QUANTITY · MENGE · QUANTITÉ · CANTIDAD · CANTIDAD · QUANTITÀ · QUANTIDADE · КОЛИЧЕСТВО	WEIGHT · GEWICHT · POIDS · PESO · PESO · PESO · ВЕС
	10×10 m UNDERCARRIAGE STRUT MOUNTING TOWER SECTION	3,00m	3,00 m	3,10 m	1	10450 kg
	10×10 m LEFT + RIGHT UNDERCARRIAGE STRUT	5,70 m	2,60 m	0,70 m	2 left + 2 right	3825 kg
	CROSSBEAM FOR TRAVELLING 10×10 m UNDERCARRIAGE	7,00 m	2,20 m	0,40 m	2	2030 kg
	10×10 m UNDERCARRIAGE ELECTRICAL BOX SUPPORT PLATFORM FOR TVF 4RT 4M9 TRAVELLING DRIVE UNIT	5,70 m	2,20 m	2,40 m	1	1300 kg
	10×10 m UNDERCARRIAGE ELECTRICAL BOX SUPPORT PLATFORM FOR TSR 4RG 4M8 TRAVELLING DRIVE UNIT	5,60 m	2,10 m	3,70 m	1	645 kg

Tower

CTT 721B-40	DESCRIPTION · BESCHREIBUNG · DESCRIPTION · DESCRIPCIÓN · DESCRIZIONE · DESCRIÇÃO · ОПИСАНИЕ	LENGTH · LÄNGE · LONGUEUR · LONGITUD · LUNGHEZZA · COMPRIMENTO · ДЛИНА	WIDTH · BREITE · LARGEUR · ANCHURA · LARGHEZZA · LARGURA · ШИРИНА	HEIGHT · HÖHE · HAUTEUR · ALTURA · ALTEZZA · ALTURA · ВЫСОТА	QUANTITY · MENGE · QUANTITÉ · CANTIDAD · CANTIDAD · QUANTITÀ · QUANTIDADE · КОЛИЧЕСТВО	WEIGHT · GEWICHT · POIDS · PESO · PESO · PESO · ВЕС
	TOWER SECTION HD23 26.6	6,00 m	2,34 m	2,32 m	1	6300 kg*
	TOWER SECTION HD23 26.3	3,00 m	2,34 m	2,32 m	1	3658 kg
	TOWER SECTION HD23 22.6	6,00 m	2,28 m	2,29 m	1	4675 kg*
	TOWER SECTION HD23 22.3	3,00 m	2,29 m	2,28 m	1	2660 kg*
	SLEWING UNIT	2,51 m	2,98 m	2,69 m	1	15500 kg







TRANSPORTATION

Transport · Transport · Transporte · Trasporto · Transporte · Транспортировка

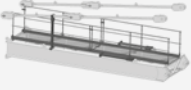
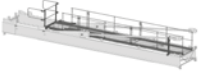
Cab

CTT 721B-40	DESCRIPTION · BESCHREIBUNG · DESCRIPTION · DESCRIPCIÓN · DESCRIZIONE · DESCRIÇÃO · ОПИСАНИЕ	LENGTH · LÄNGE · LONGUEUR · LONGITUD · LUNGHEZZA · COMPRIMENTO · ДЛИНА	WIDTH · BREITE · LARGEUR · ANCHURA · LARGHEZZA · LARGURA · ШИРИНА	HEIGHT · HÖHE · HAUTEUR · ALTURA · ALTEZZA · ALTURA · ВЫСОТА	QUANTITY · MENGE · QUANTITÀ · CANTIDAD · QUANTITÀ · QUANTIDADE · КОЛИЧЕСТВО	WEIGHT · GEWICHT · POIDS · PESO · PESO · ВЕС
	CAB SUPPORT PLATFORM	5,54 m	2,69 m	1,87 m	1	2000 kg
	CAB TOWER SECTION	2,55 m	2,17 m	3,30 m	1	4050 kg

Upper Part

	COUNTERJIB "1D"	7,16 m	0,88 m	1,87 m	1	4635 kg**
	COUNTERJIB "3D"	11,66 m	1,10 m	2,12 m	1	6200 kg**
	JIB SECTION-36 19TT19 25.12	12,00 m	2,54 m	1,87m	1	13480 kg***
	JIB SECTION-37 20TT19 25.12	10,28 m	2,56 m	1,87 m	1	7350 kg
	JIB SECTION-38 21TT19 23.10	10,29 m	1,87 m	2,54 m	1	5250 kg
	JIB SECTION-39 TT19 23.10	10,34 m	1,87 m	2,50 m	1	4150 kg
	JIB SECTION-41 TT19 23.6	6,3 m	1,87 m	2,50 m	1	2130 kg
	JIB SECTION-42 TT19 23.5	5,3 m	1,87 m	2,50 m	1	1850 kg

CTT 721B-40	DESCRIPTION · BESCHREIBUNG · DESCRIPTION · DESCRIPCIÓN · DESCRIZIONE · DESCRIÇÃO · ОПИСАНИЕ	LENGTH · LÄNGE · LONGUEUR · LONGITUD · LUNGHEZZA · COMPRIMENTO · ДЛИНА	WIDTH · BREITE · LARGEUR · ANCHURA · LARGHEZZA · LARGURA · ШИРИНА	HEIGHT · HÖHE · HAUTEUR · ALTURA · ALTEZZA · ALTURA · ВЫСОТА	QUANTITY · MENGE · QUANTITÉ · CANTIDAD · QUANTITÀ · QUANTIDADE · КОЛИЧЕСТВО	WEIGHT · GEWICHT · POIDS · PESO · PESO · ВЕС
	JIB SECTION-05 TT19 23.10	10,00 m	1,87 m	2,50 m	1	2700 kg
	JIB SECTION-06 TT19 20.10	10,29 m	1,87 m	2,18 m	1	1930 kg
	JIB SECTION-07 TT1920.05	5,28 m	1,87 m	2,18 m	1	900 kg
	JIB SECTION-08 TT1917.05	5,25 m	1,87 m	1,86 m	1	780 kg
	JIB SECTION-09 TT1917.05	5,22 m	1,87 m	1,86 m	1	640 kg
	JIB SECTION-10 TT1917.05	5,19 m	1,87 m	1,86 m	1	510 kg
	JIB POINT	2,13 m	1,24 m	1,60 m	1	355 kg
	JIB TROLLEY 32-40 t	2,58 m	2,30 m	1,56 m	1	900 kg
	4-PART LINE HOIST BLOCK 40	1,80 m	0,70 m	2,00 m	1	1165 kg****
	HOIST WINCH 94 AFC 200 D3 (VECTOR 2) (without rope)	4,56 m	2,55 m	2,51 m	1	7250 kg

* inclusive of ladders, platforms and assembly equipment

** inclusive of tie-bars and safety rails

*** inclusive of trolley winch and accessories

**** ballast plates not included

NOTES

Notizen · Note · Apunte · Appunti · Notas · Заметки

TEREX TOWER CRANES

Gru Comedil Srl

Via delle Innovazioni, 17
33074 Fontanafredda (PN)
Italy
Ph: +39 0434 989111
Email: mktg.cranes@terex.com

March 2024. Product specifications and prices are subject to change without notice or obligation. The photographs and/or drawings in this document are for illustrative purposes only. Refer to the appropriate Operator's Manual for instructions on the proper use of this equipment. Failure to follow the corresponding Operator's Manual when using our equipment or to otherwise act responsibly may result in serious injury or death. The only warranty applicable to our equipment is the standard written warranty applicable to the particular product and sale and Terex makes no other warranty, express or implied. Products and services listed may be trademarks, service marks or trade-names of Terex Corporation and/or its subsidiaries in the USA and other countries. All rights are reserved. Terex, the Terex Crown design and Works For You are trademarks of Terex Corporation or its subsidiaries.

Marzo 2024. Specifiche e prezzi dei prodotti sono soggetti a modifica senza preavviso o altro obbligo. Le fotografie e i disegni in questo documento hanno esclusivamente scopo illustrativo. Consulta il Manuale dell'operatore pertinente per trovare istruzioni per l'utilizzo corretto di questo macchinario. La mancata osservanza delle istruzioni contenute nel relativo Manuale dell'operatore durante l'uso del macchinario e altri comportamenti irresponsabili possono provocare gravi lesioni, anche mortali. L'unica garanzia applicabile ai nostri macchinari è la garanzia scritta standard applicabile al particolare prodotto e alla particolare vendita e Terex è esonerata dal fornire qualsiasi altra garanzia, esplicita o implicita. I prodotti e servizi elencati possono essere dei marchi di fabbrica, marchi di servizio o nomi commerciali di Terex Corporation, e/o delle rispettive società affiliate negli Stati Uniti d'America e in molte altre nazioni. Tutti i diritti riservati. Terex, il marchio Terex Crown e Works for You sono marchi di proprietà di Terex Corporation o delle sue società affiliate.

März 2024. Irrtum und Änderungen der Produktspezifikationen vorbehalten. Die in diesem Dokument enthaltenen Fotos und/oder Zeichnungen dienen rein anschaulichen Zwecken. Für den sachgemäßen Gebrauch der Maschinen ist das entsprechende Bedienerhandbuch heranzuziehen. Unsachgemäßer Umgang mit bzw. unsachgemäßer Einsatz unserer Maschinen kann zu schweren gesundheitlichen Schäden bis hin zum Tod führen. Für unsere Produkte wird ausschließlich die entsprechende, schriftlich niedergelegte Standardgarantie gewährt. Terex leistet keinerlei darüber hinausgehende Garantie, weder ausdrücklich noch stillschweigend. Die genannten Produkte und Dienstleistungen sind in den USA und anderen Ländern ggf. Marken, Dienstleistungsmarken oder Handelsnamen der Terex Corporation und/oder ihrer Tochtergesellschaften. Alle Rechte vorbehalten. Terex, das Terex Kronenlogo und Works For You sind Marken in Eigentum der Terex Corporation bzw. ihrer Tochtergesellschaften.

Mars 2024. Les caractéristiques et prix des produits peuvent faire l'objet de modifications sans notification préalable. Les photographies ou dessins présentés dans ce document servent uniquement à des fins d'illustration. Pour connaître les instructions relatives à l'utilisation correcte de cet équipement, veuillez vous référer au manuel de l'utilisateur correspondant. Le non-respect du manuel d'utilisateur correspondant lors de l'utilisation de notre équipement ou des actes irresponsables risquent de provoquer de graves blessures, voire un décès. La seule garantie applicable à nos équipements est la garantie écrite standard applicable au produit et à la vente spécifiques. Terex ne délivre aucune autre garantie, expresse ou implicite. Les produits et les services mentionnés peuvent être des marques, des marques de service ou des appellations commerciales de Terex Corporation et/ou de ses filiales aux États-Unis et dans d'autres pays. Tous droits réservés. Terex, le design Terex Crown et Works For You sont des marques déposées de Terex Corporation ou de ses filiales.

Marzo 2024. Las especificaciones y los precios de los productos están sujetos a cambios sin necesidad de previo aviso ni ninguna otra obligación. Las fotografías y/o dibujos de este documento tienen un fin meramente ilustrativo. Consulte el correspondiente manual de instrucciones del operario para obtener más información sobre el uso correcto de esta maquinaria. No respetar el manual del operario al utilizar la maquinaria o actuar de forma irresponsable puede provocar lesiones graves e incluso mortales. La única garantía aplicable a nuestra maquinaria es la garantía escrita estándar de cada producto y venta. Terex no amplía dicha garantía de forma expresa ni implícita. Los productos y servicios mencionados pueden ser marcas comerciales, marcas de servicio o nombres de marca de Terex Corporation o de alguna de sus filiales en Estados Unidos y otros países. Todos los derechos reservados. Terex, el diseño de la corona Terex y Works For You son marcas registradas de Terex Corporation o de sus filiales.

Março 2024. Especificações e preços dos produtos sujeitos a alteração sem aviso prévio ou obrigações. As fotografias e/ou desenhos neste documento são apenas para fins ilustrativos. Consulte o respectivo Manual do Operador para instruções sobre o uso correto deste equipamento. Deixar de acompanhar o respectivo Manual do Operador ao usar o nosso equipamento ou, por qualquer outra forma, deixar de agir de maneira responsável pode resultar em lesões corporais graves ou a morte. A única garantia aplicável ao nosso equipamento é a garantia padrão por escrito correspondente ao produto específico vendido. A Terex não dá outras garantias, expressas ou implícitas. Os produtos e serviços listados podem ser marcas comerciais, marcas de serviço ou nomes-fantasia da Terex Corporation e/ou suas subsidiárias nos EUA e em outros países. Todos os direitos reservados. Terex, o desenho da Coroa Terex e a expressão Works For You são marcas comerciais da Terex Corporation ou suas subsidiárias.

Март 2024 г. года Технические характеристики и цены могут изменяться без предварительного уведомления и без каких-либо обязательств для производителя. Фотографии и (или) чертежи в настоящем документе служат только в качестве иллюстраций. Инструкции по надлежащей эксплуатации данного оборудования см. в соответствующем руководстве для оператора. Невыполнение указаний соответствующих руководств для оператора при эксплуатации оборудования или другие безответственные действия могут повлечь серьезные травмы или смерть. Единственной гарантией, действующей в отношении нашего оборудования, является стандартная форма письменной гарантии на данный тип оборудования и на условия его продажи. Terex не дает никаких других гарантий: ни ясно выраженных, ни подразумеваемых. Перечисленные продукты и услуги могут быть торговыми марками, знаками обслуживания или торговыми наименованиями Terex Corporation и / или ее дочерних компаний в США и других странах. Все права защищены. Terex, изображение короны Terex и Works for You являются торговыми марками, принадлежащими корпорации Terex или ее дочерним компаниям.



www.terex.com/tower-cranes

Brochure Reference: TC-DS-M-E//G/F/S/P/R-CTT721B-40-03/24



WORKS FOR YOU.™