

LUFFING JIB TOWER CRANE

















Specifications:

- ▶ Max jib length: 200 ft
- ▶ Capacity at max length: 5,730 lbs
- ▶ Max capacity: 39,690 lbs

WORKS FOR YOU.™

KEY

Legenda · Zeichenerklärung · Légende · Leyenda · Legenda · Условные обозначения

	Hoisting · Sollevamento · Heben · Levage · Elevación · Elevação · Подъем
	Trolleying · Traslazione carrello · Katzfahren · Distribution · Distribución · Distribuição · Передвижение каретки
	Slewing · Rotazione · Schwenken · Orientation · Orientació · Giro · Поворот
	Luffing · Brandeggio · Ausleger-Einziehen · Relevage · Elevación de pluma · Lança basculante · Наклон стрелы
	Travelling · Traslazione · Schienenfahren · Translation · Traslación · Móvel · Передвижение
	Directive on noise level · Direttiva sul livello acustico · Richtlinie für den Schall-Leistungspegel · Directive sur le niveau acoustique · Directiva sobre el nivel acustico · Diretiva sobre nível de ruídos · Директива по уровню шума
	Consult us · Consultateci · Auf Anfrage · Nous consulter · Consultarnos · Consulte-nos · Проконсультироваться с нами
	Power requirements · Potenza totale richiesta · Geforderte Stromstärke · Puissance totale nécessaire · Potencia necesaria · Requisitos de energia · Требования по питанию
	Power supply · Alimentazione · Stromversorgung · Alimentation · Alimentación · Fonte de alimentação · Питание
	In service · In servizio · In Betrieb · En service · En servicio · Em serviço · При работе
	Out of service · Fuori servizio · Außer Betrieb · Hors service · Fuera de servicio · Fora de serviço · В режиме простоя
	Max. under hook height · Altezza max. sotto gancio · Höchste Hakenhöhe · Hauteur maxi. sous crochet · Maxima altura bajo gancho · Alt. máx. sob o gancho · Макс высота крюка
	Jib · Braccio · Ausleger · Flèche · Pluma · Lança · Стрела
	Without load, without ballast, max. jib and max. height · A vuoto, senza zavorra, braccio max., altezza max. · Ohne Last und Ballast, mit Maximalausleger und Maximalhöhe · A vide, sans lest, avec flèche et hauteur maximum · Sin carga, sin lastre, con pluma y altura máxima · Sem carga, sem lastro, lança máxima, altura máxima · Без груза, без балласта, на макс. Длине вспомогательной стрелы и макс. Высоте
	Counterweight · Zavorra controbraccio · Gegengewicht · Lest de contre-flèche · Lastre de contra flecha · Contrapeso · Противовес
C25	EN 14439-C25

CONTENTS

CTL 272-18

Indice · Inhalt · Contenu · Contenido · Sumário · Содержание

Page · Seite · Page · Página · Pagina · Página · Страница:

Load Diagram · Diagramma di portata · Lastkurven · Courbes de charges · Curvas de cargas · Diagrama de carga · Диаграмма грузоподъёмности	4
Tower · Torre · Turm · Tour · Torre · Torre · Башня	7
Mechanisms · Meccanismi · Antriebe · Mécanismes · Mecanismos · Mecanismo · Механизм	14
Transportation · Trasporto · Transport · Transport · Transporte · Transporte · Транспортировка	16

LOAD DIAGRAM

Diagramma di portata · Lastkurven · Courbes de charges · Curvas de cargas · Diagrama de carga · Схема нагрузок

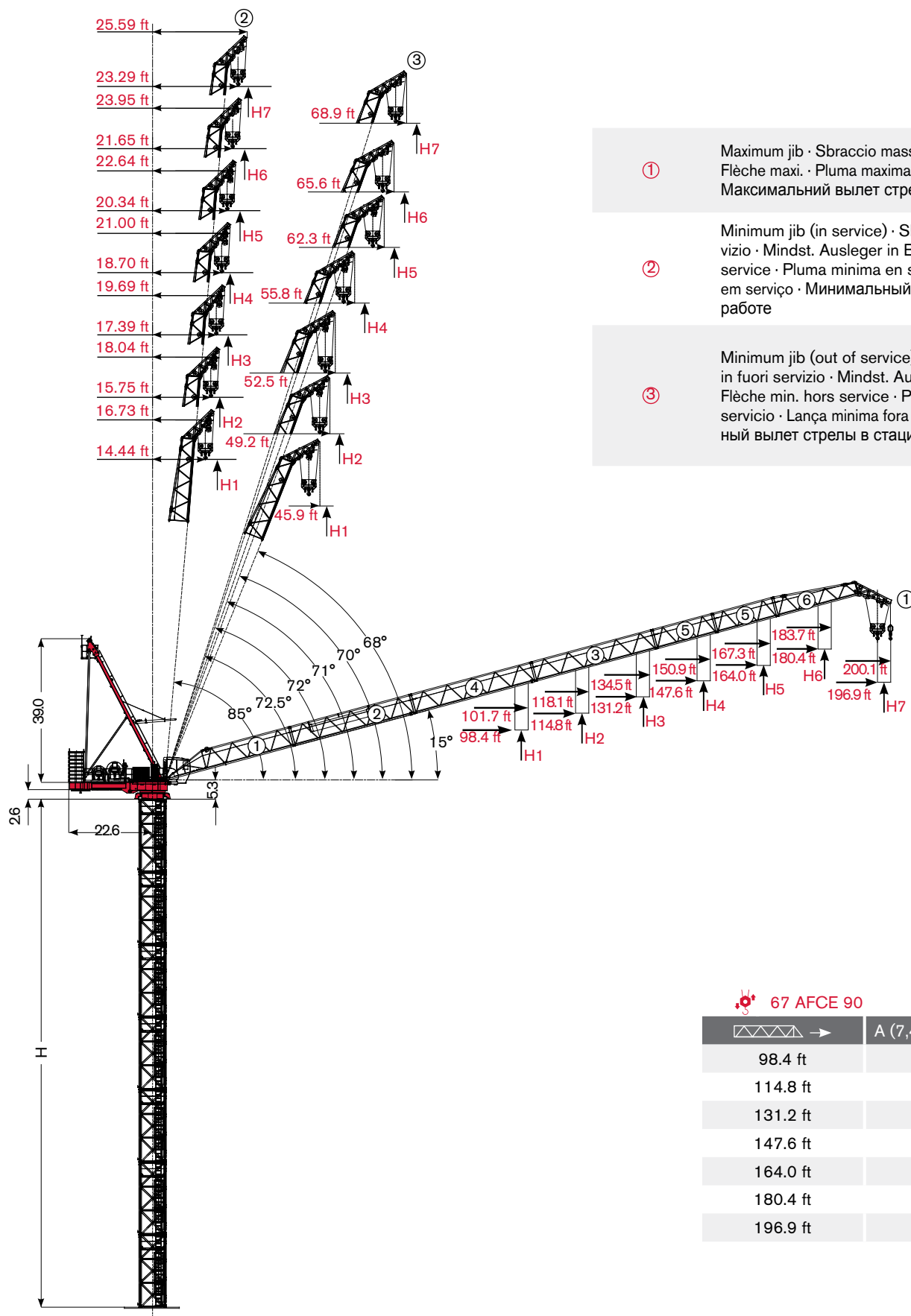

①

Maximum jib · Sbraccio massimo · Max. Ausleger · Flèche maxi · Pluma maxima · Lança maxima · Максимальный вылет стрелы



②

Minimum jib (in service) · Sbraccio minimo in servizio · Mindst. Ausleger in Betrieb · Flèche min. en service · Pluma minima en servicio · Lança minima em serviço · Минимальный вылет стрелы при работе

③

Minimum jib (out of service) · Sbraccio minimo in fuori servizio · Mindst. Ausleger außer Betrieb · Flèche min. hors service · Pluma minima fuera de servicio · Lança minima fora de serviço · Минимальный вылет стрелы в стационарном состоянии

Load Diagram · Diagramma di portata · Lastkurven · Courbes de charges · Curvas de cargas · Diagrama de carga · Диаграмма грузоподъёмности

		49.2 ft	65.6 ft	82.0 ft	98.4 ft	101.7 ft	114.8 ft	118.1 ft	131.2 ft	134.5 ft	147.6 ft	150.9 ft	164.0 ft	167.3 ft	180.4 ft	183.7 ft	196.9 ft	200.1 ft
	10,143 lbs → 149.5 ft lbs	10,143	10,143	10,143	10,143	10,143	10,143	10,143	10,143	10,143	10,143	9,975	8,595	8,284	7,152	6,895	5,950	5,733
	19,845 lbs → 94.4 ft lbs	19,845	19,845	19,845	18,743	17,903	15,026	14,406	12,238	11,762	10,070	9,692	8,335	8,029	6,916	6,662	5,733	
	10,143 lbs → 153.5 ft lbs	10,143	10,143	10,143	10,143	10,143	10,143	10,143	10,143	10,143	10,143	10,143	9,023	8,703	7,541	7,277		
	19,845 lbs → 96.8 ft lbs	19,845	19,845	19,845	19,404	18,543	15,593	14,957	12,734	12,246	10,511	10,124	8,732	8,418	7,277			
	29,768 lbs → 68.7 ft lbs	29,768	29,768	23,770	18,596	17,761	14,900	14,284	12,128	11,654	9,972	9,597	8,247	7,942	6,836			
	10,143 lbs → 167.3 ft lbs	10,143	10,143	10,143	10,143	10,143	10,143	10,143	10,143	10,143	10,143	10,143	10,143	10,143				
	19,845 lbs → 108 ft lbs	19,845	19,845	19,845	19,845	19,845	18,239	17,530	15,049	14,505	12,569	12,137	10,584					
	29,768 lbs → 75.2 ft lbs	29,768	29,768	26,681	21,021	20,108	16,979	16,305	13,947	13,429	11,589	11,178	9,702					
	39,690 lbs → 59.3 ft lbs	39,690	35,170	26,681	21,021	20,108	16,979	16,305	13,947	13,429	11,589	11,178	9,702					
	10,143 lbs → 150.9 ft lbs	10,143	10,143	10,143	10,143	10,143	10,143	10,143	10,143	10,143	10,143	10,143						
	19,845 lbs → 110.4 ft lbs	19,845	19,845	19,845	19,845	19,845	18,806	18,081	15,545	14,989	13,010							
	29,768 lbs → 77.3 ft lbs	29,768	29,768	27,651	21,830	20,891	17,672	16,979	14,553	14,021	12,128							
	39,690 lbs → 61.0 ft lbs	39,690	36,383	27,651	21,830	20,891	17,672	16,979	14,553	14,021	12,128							
	10,143 lbs → 134.5 ft lbs	10,143	10,143	10,143	10,143	10,143	10,143	10,143	10,143	10,143								
	19,845 lbs → 113.1 ft lbs	19,845	19,845	19,845	19,845	19,845	19,436	18,694	16,097									
	29,768 lbs → 79.7 ft lbs	29,768	29,768	28,709	22,712	21,744	18,428	17,714	15,215									
	39,690 lbs → 62.8 ft lbs	39,690	37,706	28,709	22,712	21,744	18,428	17,714	15,215									
	10,143 lbs → 118.1 ft lbs	10,143	10,143	10,143	10,143	10,143	10,143	10,143										
	19,845 lbs → 113.9 ft lbs	19,845	19,845	19,845	19,845	19,845	19,625											
	29,768 lbs → 80.7 ft lbs	29,768	29,768	29,150	23,079	22,100	18,743											
	39,690 lbs → 63.6 ft lbs	39,690	38,257	29,150	23,079	22,100	18,743											
	10,143 lbs → 101.7 ft lbs	10,143	10,143	10,143	10,143	10,143												
	19,845 lbs → 98.4 ft lbs	19,845	19,845	19,845	19,845													
	29,768 lbs → 80.8 ft lbs	29,768	29,768	29,238	23,153													
	39,690 lbs → 63.8 ft lbs	39,690	38,367	29,238	23,153													

Jib and Tower Height Configurations · Configurazioni torre e braccio · Ausleger- und Turmkonfigurationen · Configurations de la flèche et du mât · Configuraciones de pluma y torre · Configuração de lança e altura de torre · Конфигурация башни и стрелы

	
98.4 ft	1 + 2 + 6
114.8 ft	1 + 2 + 5 + 6
131.2 ft	1 + 2 + 3 + 6
147.6 ft	1 + 2 + 3 + 5 + 6
164.0 ft	1 + 2 + 3 + 4 + 6
180.4 ft	1 + 2 + 4 + 3 + 5 + 6
196.9 ft	1 + 2 + 4 + 3 + 5 + 5 + 6

	H		
	①	②	③
H1	H + 11.5 ft	H + 86.0 ft	H + 78.7 ft
H2	H + 15.7 ft	H + 103.0 ft	H + 95.8 ft
H3	H + 20.3 ft	H + 119.8 ft	H + 113.2 ft
H4	H + 24.6 ft	H + 136.8 ft	H + 129.6 ft
H5	H + 29.2 ft	H + 153.9 ft	H + 144.7 ft
H6	H + 33.5 ft	H + 170.6(*) ft	H + 159.4(*) ft
H7	H + 37.7 ft	H + 187.3(**) ft	H + 178.5(**) ft

(*) Configuration III Falls

(**) Configuration II Falls

LOAD DIAGRAM

Diagramma di portata · Lastkurven · Courbes de charges · Curvas de cargas · Diagrama de carga · Схема нагрузки

TEREX POWER PLUS

		49.2 ft	65.6 ft	82.0 ft	98.4 ft	101.7 ft	114.8 ft	118.1 ft	131.2 ft	134.5 ft	147.6 ft	150.9 ft	164.0 ft	167.3 ft	180.4 ft	183.7 ft	196.9 ft	200.1 ft
	10,143 lbs → 157.4 ft lbs	10,143	10,143	10,143	10,143	10,143	10,143	10,143	10,143	10,143	10,143	10,143	9,434	9,107	7,915	7,644	6,649	6,421
	19,845 lbs → 99.4 ft lbs	19,845	19,845	19,845	19,845	19,235	16,205	15,553	13,270	12,769	10,987	10,590	9,160	8,838	7,666	7,399	6,421	
	10,143 lbs → 162.7 ft lbs	10,143	10,143	10,143	10,143	10,143	10,143	10,143	10,143	10,143	10,143	10,143	10,001	9,662	8,430	8,150		
	19,845 lbs → 102.6 ft lbs	19,845	19,845	19,845	19,845	19,845	16,965	16,291	13,934	13,417	11,578	11,168	9,692	9,360	8,150			
	29,768 lbs → 72.7 ft lbs	29,768	29,768	25,574	20,099	19,216	16,188	15,537	13,255	12,755	10,974	10,577	9,149	8,827	7,656			
	10,143 lbs → 167.3 ft lbs	10,143	10,143	10,143	10,143	10,143	10,143	10,143	10,143	10,143	10,143	10,143	10,143	10,143				
	19,845 lbs → 115.7 ft lbs	19,845	19,845	19,845	19,845	19,845	19,845	19,294	16,637	16,053	13,980	13,518	11,854					
	29,768 lbs → 80.3 ft lbs	29,768	29,768	29,009	22,961	21,986	18,642	17,922	15,402	14,849	12,882	12,444	10,866					
	39,690 lbs → 63.4 ft lbs	39,690	38,080	29,009	22,961	21,986	18,642	17,922	15,402	14,849	12,882	12,444	10,866					
	10,143 lbs → 150.9 ft lbs	10,143	10,143	10,143	10,143	10,143	10,143	10,143	10,143	10,143	10,143	10,143						
	19,845 lbs → 118.9 ft lbs	19,845	19,845	19,845	19,845	19,845	19,845	19,845	17,302	16,702	14,571							
	29,768 lbs → 83.1 ft lbs	29,768	29,768	29,768	24,012	23,003	19,543	18,798	16,190	15,618	13,583							
	39,690 lbs → 65.6 ft lbs	39,690	39,657	30,270	24,012	23,003	19,543	18,798	16,190	15,618	13,583							
	10,143 lbs → 134.5 ft lbs	10,143	10,143	10,143	10,143	10,143	10,143	10,143	10,143	10,143								
	19,845 lbs → 122.4 ft lbs	19,845	19,845	19,845	19,845	19,845	19,845	19,845	18,028									
	29,768 lbs → 86.1 ft lbs	29,768	29,768	29,768	25,146	24,100	20,514	19,742	17,040									
	39,690 lbs → 67.9 ft lbs	39,690	39,690	31,630	25,146	24,100	20,514	19,742	17,040									
	10,143 lbs → 118.1 ft lbs	10,143	10,143	10,143	10,143	10,143	10,143	10,143										
	19,845 lbs → 114.8 ft lbs	19,845	19,845	19,845	19,845	19,845	19,845											
	29,768 lbs → 87.6 ft lbs	29,768	29,768	29,768	25,703	24,639	20,992											
	39,690 lbs → 69.1 ft lbs	39,690	39,690	32,299	25,703	24,639	20,992											
	10,143 lbs → 101.7 ft lbs	10,143	10,143	10,143	10,143	10,143												
	19,845 lbs → 98.4 ft lbs	19,845	19,845	19,845	19,845													
	29,768 lbs → 88.2 ft lbs	29,768	29,768	29,768	25,931													
	39,690 lbs → 69.6 ft lbs	39,690	39,690	32,572	25,931													

T
P
P

TOWER

CTL 272-18

Torre · Turm · Tour · Torre · Torre · Башня

Standard Configurations · Installazioni Standard · Standardkonfiguration · Standard Implantations · Implantaciones Standard · Configuração padrão · Стандартная конфигурация крана

H20

Tower: H20 & Basement: RTL

R1	-2933 kN	-3325 kN
R2	2280 kN	2813 kN
	963 kN	

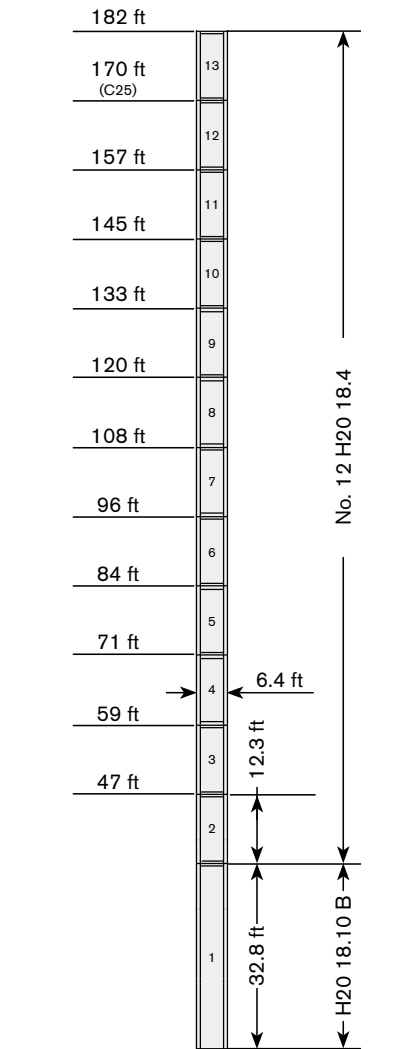

→	max. H (ft)	
	FEM 1001	FEM 1005 C25
98 ft	182	170
115 ft	182	170
131 ft	170	157
148 ft	170	157
164 ft	157	145
180 ft	145	145
197 ft	145	133

Tower: H20 & Basement: FTR

R1	-1492 kN	-1505 kN
R2	0 kN	0 kN
	988 kN	

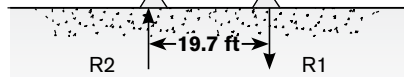
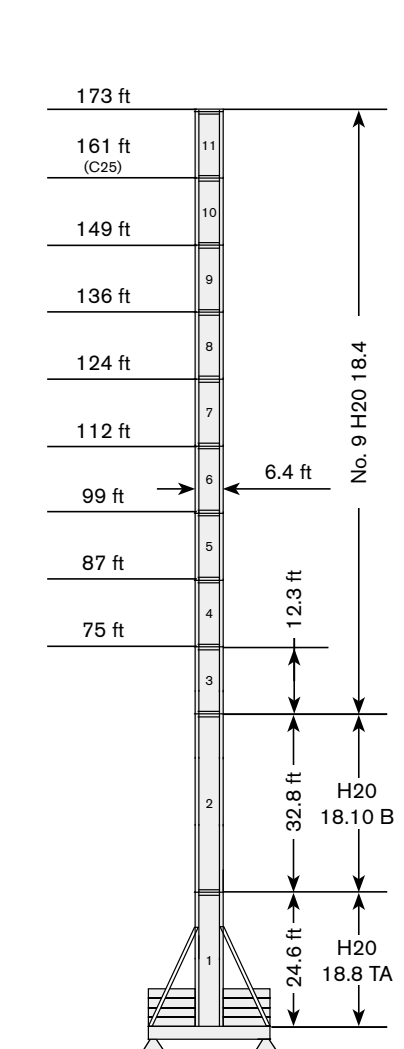

→	max. H (ft)	
	FEM 1001	FEM 1005 C25
98 ft	173	161
115 ft	161	149
131 ft	161	149
148 ft	149	136
164 ft	136	136
180 ft	136	124
197 ft	124	124

Tower: H20 & Basement: TTR

R1	-1343 kN	-1010 kN
R2	0 kN	-57 kN
	874 kN	

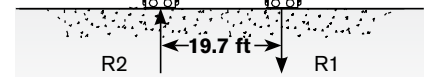
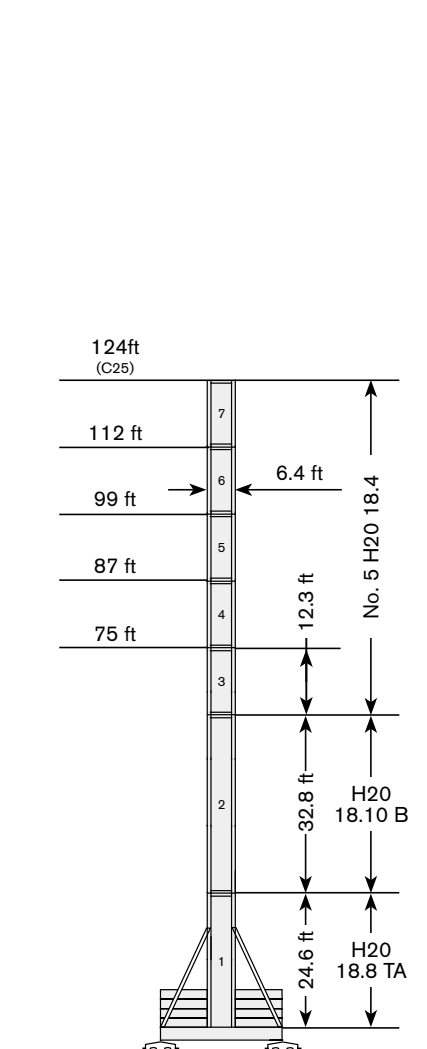

→	max. H (ft)	
	FEM 1001	FEM 1005 C25
98 ft	124	124
115 ft	124	124
131 ft	112	112
148 ft	99	99
164 ft	99	99
180 ft	99	99
197 ft	87	87

Tower height · Altezza torre · Turmhohe · Hauteur mat · Altura torre · Altura torre · Высота башни

Different heights and tower combinations are available; please consult us · Altezze diverse e combinazioni di torre sono disponibili; consultateci · Andere Höhen und Turmcombinationen auf Anfrage · Différentes hauteurs et combinaisons de tour sont disponibles; nous consulter · Hay diferentes alturas y combinaciones de torre disponibles. Consultémos · Diferentes alturas e combinações de torres disponíveis; fale conosco · Возможны другие сочетания высоты и конфигурации башни; проконсультируйтесь с нами

WORKS FOR YOU.™

TOWER

Torre · Turm · Tour · Torre · Torre · Башня

Other configurations · Altre Installazioni · Aufstellmöglichkeiten · Autres Implantations · Otras Implantaciones · Outras configurações · Другие конфигурации

Bottom climbing crane · Gru climbing · Kletterkran im Gebäude · Télescopage sur dalles · Telescopage grúa trepadora · Guindaste automontante interno · Самоподъемный кран

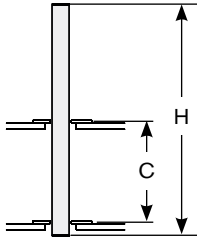

Tower: H20 (C25)

→	C	H
i		

Crane tied to the structure · Gru ancorata · Geankerter Kran · Grue ancrée · Grúa anclada · Guindaste ancorado na estrutura · Кран, крепящийся к сооружению

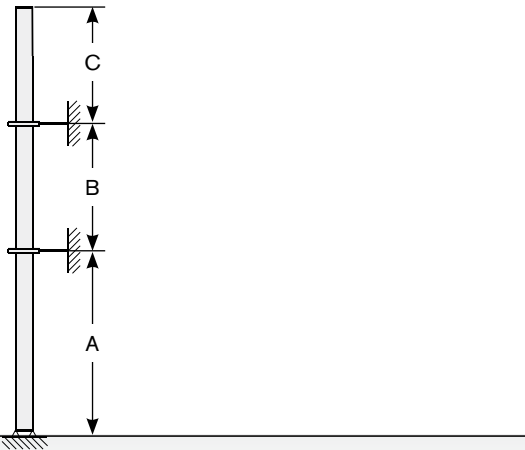

Tower: H20 - H 328 ft (C25)

→	A min/max	B min/max	C max
98 ft	115 ft / 148 ft	69 ft / 98 ft	105 ft
115 ft	115 ft / 148 ft	69 ft / 98 ft	105 ft
131 ft	98 ft / 131 ft	69 ft / 98 ft	105 ft
148 ft	98 ft / 131 ft	69 ft / 98 ft	98 ft
164 ft	98 ft / 131 ft	69 ft / 98 ft	89 ft
180 ft	98 ft / 131 ft	69 ft / 98 ft	89 ft
197 ft	82 ft / 115 ft	69 ft / 98 ft	79 ft

Tower: H20 - H 656 ft (C25)

→	A min/max	B min/max	C max
98 ft	115 ft / 148 ft	69 ft / 98 ft	105 ft
115 ft	115 ft / 148 ft	69 ft / 98 ft	98 ft
131 ft	98 ft / 131 ft	69 ft / 98 ft	98 ft
148 ft	98 ft / 131 ft	69 ft / 98 ft	89 ft
164 ft	98 ft / 131 ft	69 ft / 98 ft	79 ft
180 ft	98 ft / 131 ft	69 ft / 98 ft	79 ft
197 ft	82 ft / 115 ft	69 ft / 98 ft	69 ft

Standard Configurations · Installazioni Standard · Standardkonfiguration · Standard Implantations · Implantaciones Standard · Configuração padrão · Стандартная конфигурация крана

HD23

Tower: HD23 & Basement: R1

	●	◊
R1	-2818 kN	-3989 kN
R2	2112 kN	3456 kN
	1054 kN	

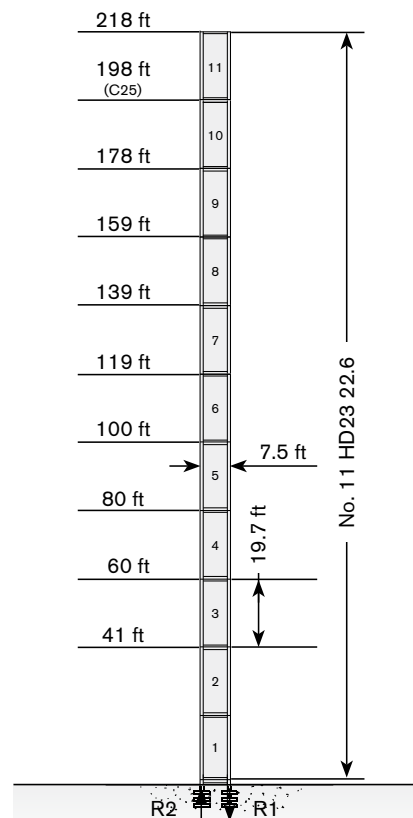

Tower: HD23 & Basement: R2

	●	◊
R1	-3226 kN	-5147 kN
R2	2453 kN	4526 kN
	1181 kN	

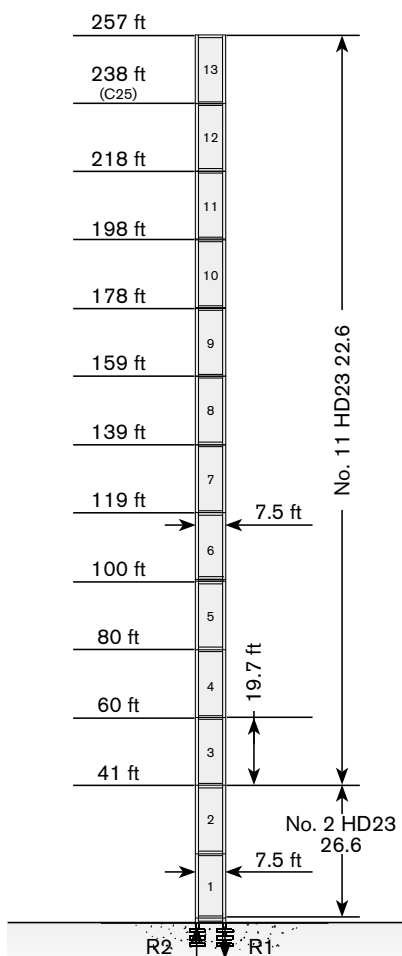

Tower: HD23 & Basement: R3

	●	◊
R1	-3621 kN	-6368 kN
R2	2792 kN	5720 kN
	1288 kN	

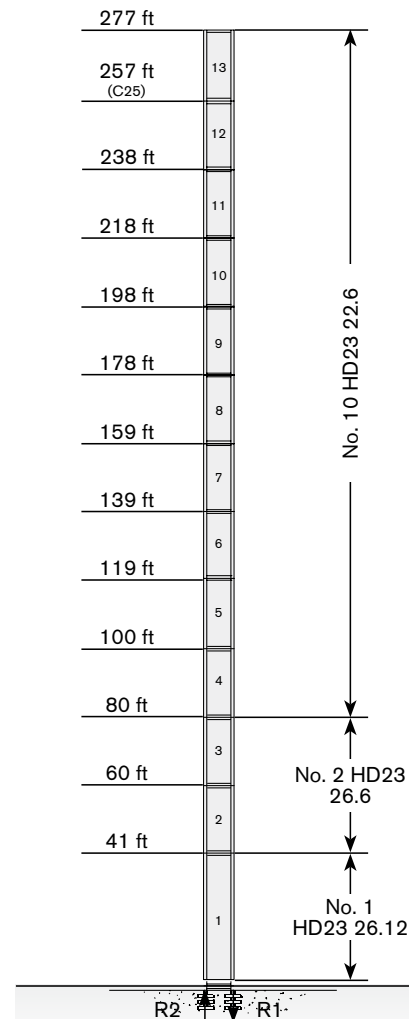

Tower height · Altezza torre · Turmhohe · Hauteur mat · Altura torre · Altura torre · Высота башни

Different heights and tower combinations are available; please consult us · Altezze diverse e combinazioni di torre sono disponibili; consultateci · Andere Höhen und Turmkombinationen auf Anfrage · Différentes hauteurs et combinaisons de tour sont disponibles; nous consulter · Hay diferentes alturas y combinaciones de torre disponibles. Consultémos · Diferentes alturas e combinações de torres disponíveis; fale conosco · Возможны другие сочетания высоты и конфигурации башни; проконсультируйтесь с нами

WORKS FOR YOU.™

TOWER

Torre · Turm · Tour · Torre · Torre · Башня

Standard Configurations · Installazioni Standard · Standardkonfiguration · Standard Implantations · Implantaciones Standard · Configuração padrão · Стандартная конфигурация крана

Tower: HD23 & Basement: FP1

R1	-1489 kN	-1840 kN
R2	-190 kN	0 kN
	1231 kN	

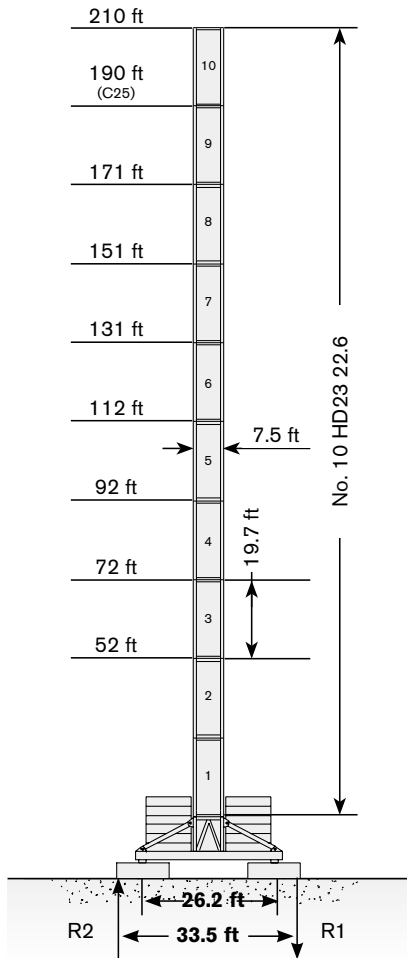

→	max. H (ft)	
	FEM 1001	FEM 1005 C25
		
98 ft	210	190
115 ft	210	190
131 ft	210	190
148 ft	190	190
164 ft	190	171
180 ft	190	171
197 ft	171	171

Tower: HD23 & Basement: T1

R1	-1458 kN	-1631 kN
R2	-45 kN	0 kN
	1280 kN	

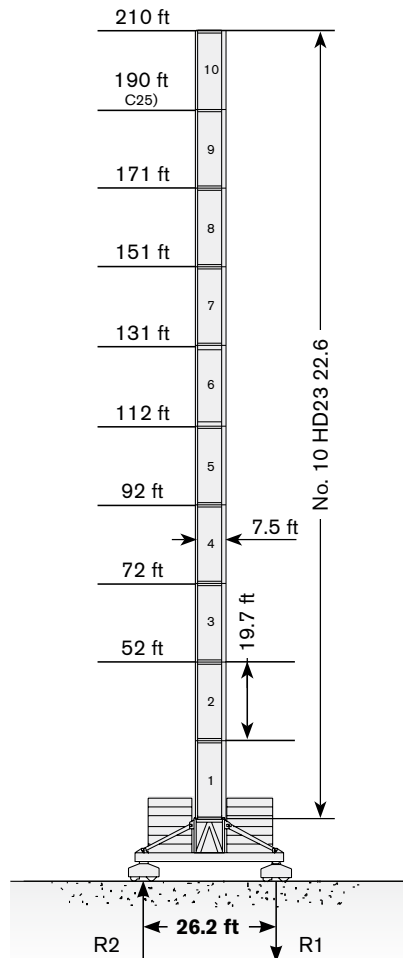

→	max. H (ft)	
	FEM 1001	FEM 1005 C25
		
98 ft	210	190
115 ft	190	171
131 ft	190	171
148 ft	171	171
164 ft	171	151
180 ft	171	151
197 ft	151	151

Other configurations · Altre Installazioni · Aufstellmöglichkeiten · Autres Implantations · Otras Implantaciones · Outras configurações · Другие конфигурации

Bottom climbing crane · Gru climbing · Kletterkran im Gebäude · Télescope sur dalles · Telescopage grúa trepadora · Guindaste automontante interno · Самоподъемный кран

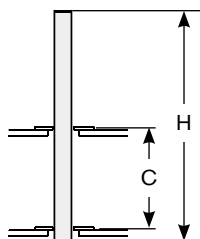

Tower: HD23 (C25)

→	C	H
98 ft - 131 ft	33 ft	138 ft
	43 ft	157 ft
	52 ft	177 ft
148 ft - 180 ft	33 ft	118 ft
	43 ft	138 ft
	52 ft	157 ft
197 ft	33 ft	98 ft
	43 ft	118 ft
	52 ft	138 ft

Crane tied to the structure · Gru ancorata · Geankerter Kran · Grue ancrée · Grúa anclada · Guindaste ancorado na estrutura · Кран, крепящийся к сооружению

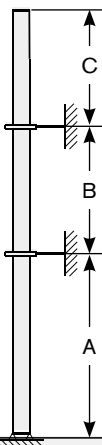

Tower: HD23 - H 328 ft (C25)

→	A min/max	B min/max	C max
98 ft	138 ft / 177 ft	69 ft / 98 ft	98 ft
115 ft	138 ft / 177 ft	69 ft / 98 ft	98 ft
131 ft	138 ft / 177 ft	69 ft / 98 ft	92 ft
148 ft	118 ft / 157 ft	69 ft / 98 ft	82 ft
164 ft	118 ft / 157 ft	69 ft / 98 ft	79 ft
180 ft	118 ft / 157 ft	69 ft / 98 ft	79 ft
197 ft	98 ft / 138 ft	69 ft / 98 ft	72 ft

Tower: HD23 - H 656 ft (C25)

→	A min/max	B min/max	C max
98 ft	118 ft / 157 ft	69 ft / 98 ft	98 ft
115 ft	118 ft / 157 ft	69 ft / 98 ft	98 ft
131 ft	118 ft / 157 ft	69 ft / 98 ft	92 ft
148 ft	118 ft / 138 ft	69 ft / 98 ft	82 ft
164 ft	118 ft / 138 ft	69 ft / 98 ft	79 ft
180 ft	98 ft / 138 ft	69 ft / 98 ft	72 ft
197 ft	98 ft / 118 ft	69 ft / 98 ft	69 ft

TOWER

Torre · Turm · Tour · Torre · Torre · Башня

Standard Configurations · Installazioni Standard · Standardkonfiguration · Standard Implantations · Implantaciones Standard · Configuração padrão · Стандартная конфигурация крана

TS212

Tower: TS212 & Basement: R4

	●	◊
R1	-2360 kN	-2881 kN
R2	1721 kN	2388 kN
	930 kN	

Tower: TS212 & Basement: FP4

	●	◊
R1	-1342 kN	-1580 kN
R2	-136 kN	0 kN
	1131 kN	

Tower: TS212 & Basement: T4

	●	◊
R1	-1378 kN	-1555 kN
R2	0 kN	0 kN
	1130 kN	

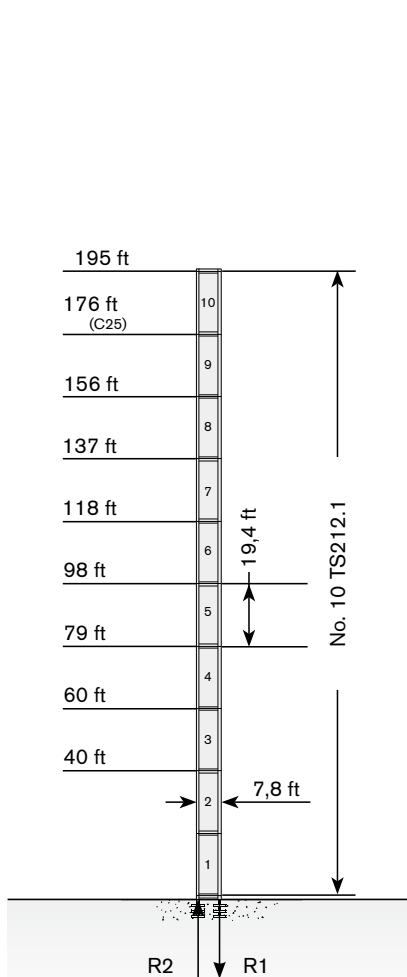

→	max. H (ft)	
	FEM 1001	FEM 1005 C25
		
98 ft	195	176
115 ft	176	176
131 ft	176	156
148 ft	176	156
164 ft	156	156
180 ft	156	137
197 ft	137	137

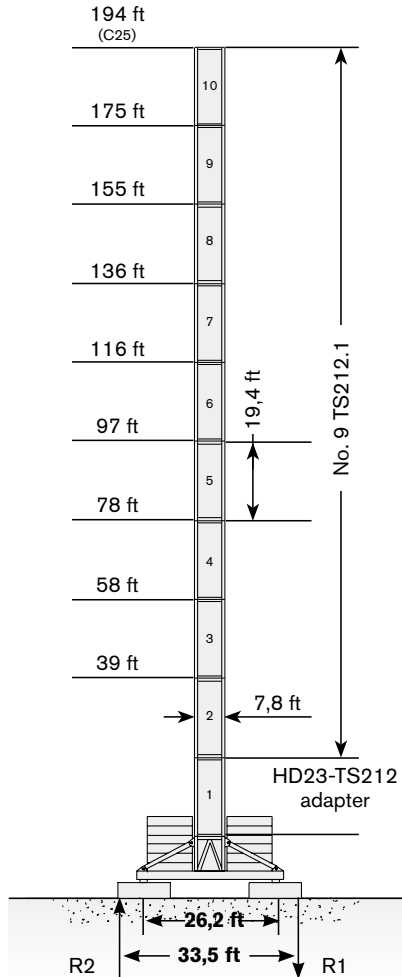

→	max. H (ft)	
	FEM 1001	FEM 1005 C25
		
98 ft	194	194
115 ft	194	175
131 ft	194	175
148 ft	175	175
164 ft	175	155
180 ft	175	155
197 ft	155	155

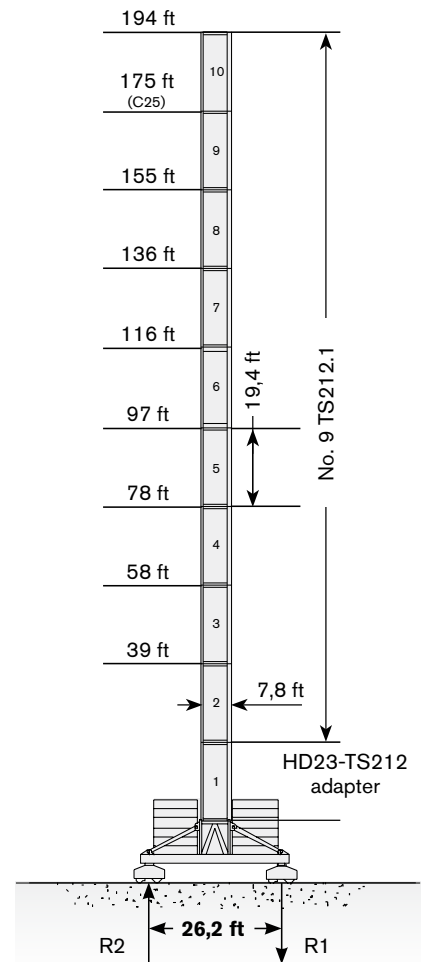

→	max. H (ft)	
	FEM 1001	FEM 1005 C25
		
98 ft	194	175
115 ft	194	175
131 ft	175	175
148 ft	175	155
164 ft	175	155
180 ft	175	155
197 ft	155	155

Max. under hook height · Altezza max. sotto gancio · Höchste Hakenhöhe · Hauteur maxi. sous crochet · Maxima altura bajo gancho · Alt. máx. sob o gancho · макс высота крюка

Different heights and tower combinations are available; please consult us · Altezze diverse e combinazioni di torre sono disponibili; consultateci · Andere Höhen und Turmkombinationen auf Anfrage · Différentes hauteurs et combinaisons de tour sont disponibles; nous consulter · Hay diferentes alturas y combinaciones de torre disponibles. Consúltenos · Diferentes alturas e combinações de torres disponíveis; fale conosco · Возможны другие сочетания высоты и конфигурации башни; проконсультируйтесь с нами

Other configurations · Altre Installazioni · Aufstellmöglichkeiten · Autres Implantations · Otras Implantaciones · Outras configurações · Другие конфигурации

Crane tied to the structure · Gru ancorata · Geankerter Kran · Grue ancrée · Grúa anclada · Guindaste ancorado na estrutura · Кран, крепящийся к сооружению

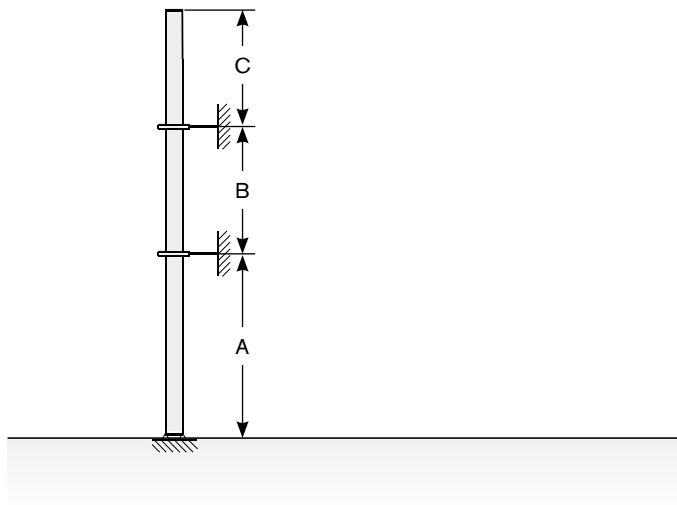

Tower: TS212 - H 328 ft (C25)

→	A min/max	B min/max	C max
98 ft	115 ft / 148 ft	79 ft / 98 ft	118 ft
115 ft	115 ft / 148 ft	79 ft / 98 ft	118 ft
131 ft	98 ft / 131 ft	79 ft / 98 ft	108 ft
148 ft	98 ft / 131 ft	79 ft / 98 ft	98 ft
164 ft	98 ft / 131 ft	69 ft / 98 ft	89 ft
180 ft	98 ft / 131 ft	69 ft / 98 ft	82 ft
197 ft	92 ft	69 ft / 98 ft	75 ft





Tower: TS212 - H 656 ft (C25)

→	A min/max	B min/max	C max
98 ft	115 ft / 148 ft	79 ft / 98 ft	98 ft
115 ft	115 ft / 148 ft	79 ft / 98 ft	98 ft
131 ft	98 ft / 131 ft	79 ft / 98 ft	89 ft
148 ft	98 ft / 131 ft	79 ft / 98 ft	82 ft
164 ft	98 ft / 131 ft	69 ft / 98 ft	69 ft
180 ft	98 ft / 131 ft	69 ft / 98 ft	69 ft
197 ft	98 ft / 115 ft	69 ft / 98 ft	69 ft

MECHANISMS

Meccanismi · Antriebe · Mécanismes · Mecanismos · Mecanismo · Механизм

Power supply · Alimentazione · Stromversorgung · Alimentation · Suministro eléctrico · Requisitos de energia · Требования по питанию

				
	45 LFCE	173 kVA*	400V - 50Hz / 460V - 60Hz	2000/14/CE modificata
	67 LFCE	190 kVA*	400V - 50Hz / 460V - 60Hz	2000/14/CE modificata

* Average consumption · Consumo medio · Durchschnittsverbrauch · Consommation moyenne · Consumo medio · Consumo médio · Среднее потребление

Hoisting · Heben · Levage · Elevación · Sollevamento · Elevação · Подъем

			lbs	ft/min	kW	
	67 AFCE 90		9,920	0 → 255	67	3,018 ft
			7,720	0 → 325		
			5,510	0 → 445		
			3,310	0 → 695		
			2,870	0 → 755		
			19,840	0 → 125		
			13,230	0 → 180		
			8,820	0 → 250		
			5,510	0 → 370		
			2,760	0 → 590		
			29,760	0 → 85		
			19,840	0 → 130		
			12,130	0 → 200		
			7,720	0 → 300		
			5,730	0 → 390		
			39,680	0 → 60		
			26,460	0 → 90		
			17,640	0 → 125		
	11,020	0 → 190				
	5,510	0 → 300				

Hoisting Speed · Velocità di Sollevamento · Heben Geschwindigkeit · Vitesse de Levage · Velocidad de Elevación · Velocidade de içamento · Скорость подъема

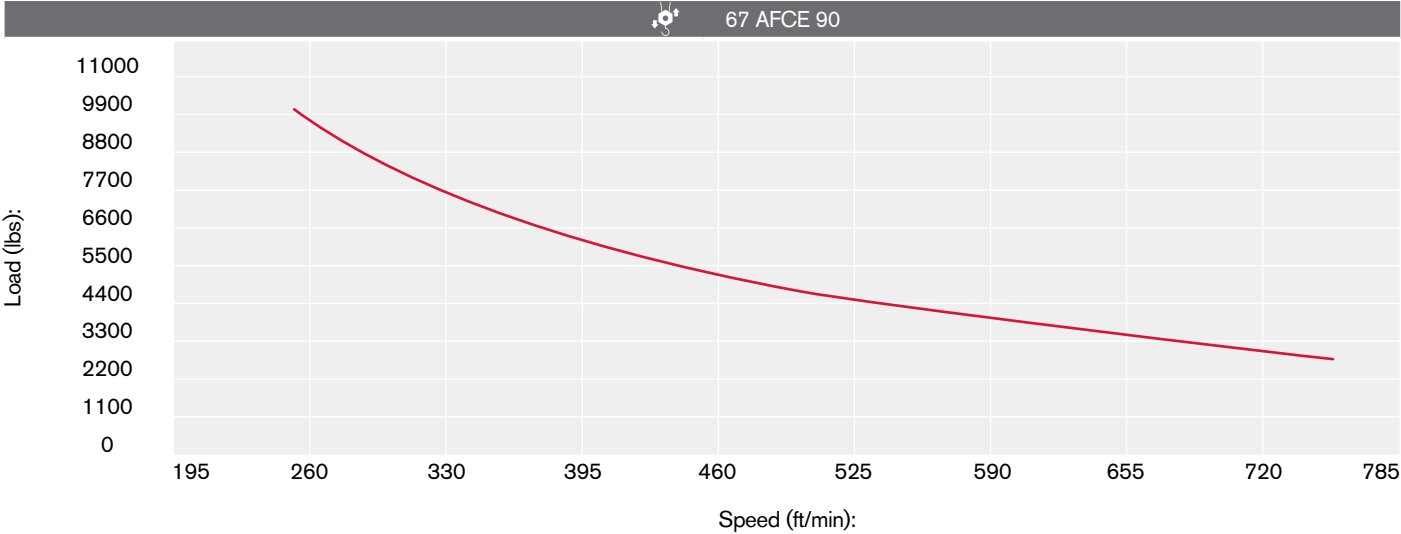

Additional Specifications · Altre movimentazioni · Weitere Leistungsdaten · Spécifications additionnelles · Otras prestaciones · Especificações adicionais · Дополнительные спецификации







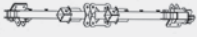

	45 LFCE	2,2 min	45 kW
	67 LFCE	1,4 min	67 kW
	SVF 2 2 11	0 → 0,80 r.p.m.	2 x 11 kW

TRANSPORTATION



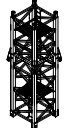

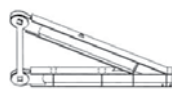





Transport · Transport · Transporte · Trasporto · Transporte · Транспортировка

Packing list

Undercarriage

CTL 272-18 H20	DESCRIPTION · DESCRIZIONE · BESCHREIBUNG · DESCRIPTION · DESCRIPCIÓN · DESCRIÇÃO · ОПИСАНИЕ	LENGTH · LUNGHEZZA · LÄNGE · LONGUEUR · LONGITUD · COMPIMENTO · ДЛИНА	WIDTH · LARGHEZZA · BREITE · LARGEUR · ANCHURA · LARGURA · ШИРИНА	HEIGHT · ALTEZZA · HÖHE · HAUTEUR · ALTURA · ALTURA · ВЫСОТА	QUANTITY · QUANTITÀ · MENGE · QUANTITÉ · CANTIDAD · QUANTIDADE · КОЛИЧЕСТВО	WEIGHT · PESO · GEWICHT · POIDS · PESO · PESO · ВЕС
	19.7 x 19.7 ft UNDERCARRIAGE LONG BEAM	29' 4"	1' 8"	3' 5"	1	4,603 lb
	19.7 x 19.7 ft UNDERCARRIAGE SHORT BEAM	14' 5"	1' 8"	3' 5"	2	2,227 lb
	19.7 x 19.7 ft UNDERCARRIAGE JOINING SLEEPER	18' 1"	0' 6"	1' 7"	2	617 lb
	19.7 x 19.7 ft UNDERCARRIAGE JOINING SLEEPER	18' 1"	0' 6"	1' 7"	2	485 lb
	19.7 x 19.7 ft UNDERCARRIAGE STRUT	16' 9"	0' 9"	0' 12"	4	1,102 lb
	STRUT MOUNTING TOWER ELEMENT HA20 18.8TA FOR 19.7 x 19.7 ft UNDERCARRIAGE	24' 7"	7' 7"	7' 7"	1	14,683 lb **
CTL 272-18 HD23						
	26.2 x 26.2 ft UNDERCARRIAGE STRUT MOUNTING TOWER SECTION	9' 6"	9' 6"	9' 6"	1	20,172 lb
	26.2 x 26.2 ft UNDERCARRIAGE STRUT	14' 1"	0' 12"	7' 5"	4	4,012 lb
	26.2 x 26.2 ft UNDERCARRIAGE INTERNAL BEAM	13' 1"	0' 6"	1' 1"	4	463 lb
	26.2 x 26.2 ft UNDERCARRIAGE EXTERNAL BEAM	19' 7"	0' 12"	1' 1"	4	1,380 lb

Tower

CTL 272-18 H20	DESCRIPTION · DESCRIZIONE · BESCHREIBUNG · DESCRIPTION · DESCRIPCION · DESCRIÇÃO · ОПИСАНИЕ	LENGTH · LUNGHEZZA · LANGE · LONGUEUR · LONGITUD · COMPRIMENTO · ДЛИНА	WIDTH · LARGHEZZA · BREITE · LARGEUR · ANCHURA · LARGURA · ШИРИНА	HEIGHT · ALTEZZA · HÖHE · HAUTEUR · ALTURA · ALTURA · ВЫСОТА	QUANTITY · QUANTITÀ · MENGE · QUANTITÉ · CANTIDAD · QUANTIDADE · КОЛИЧЕСТВО	WEIGHT · PESO · GEWICHT · POIDS · PESO · PESO · BEC
	HA20 18.10 B TOWER ELEMENT	32' 10"	6' 7"	6' 5"	1	15,432 lb **
	HA20 18.4 S TOWER ELEMENT	12' 4"	6' 7"	6' 5"	1	6,515 lb **
	SLEWING UNIT H20	10' 8"	8' 8"	7' 9"	1	21,605 lb
CTL 272-18 TS 212						
	TOWER SECTION TS 212.1		19' 6"	7' 9"	8' 0"	9,304 lb
	TOWER SECTION TSV 212.1		31' 2"	9' 10"	10' 0"	20,503 lb
	TOWER SECTION TSK 212		10' 4"	8' 8"	7' 7"	6,283 lb
CTL 272-18 HD23						
	TOWER SECTION HD23 26.6	19' 8"	7' 8"	7' 7"	1	13,889 lb **
	TOWER SECTION HD23 26.3	9' 10"	7' 8"	7' 7"	1	8,065 lb **
	TOWER SECTION HD23 22.6	19' 8"	7' 6"	7' 6"	1	10,307 lb **
	TOWER SECTION HD23 22.3	9' 10"	7' 6"	7' 6"	1	5,864 lb **
	SLEWING UNIT HD23	11' 6"	8' 8"	6' 4"	1	22,267 lb

* including ladders, platforms, assembly equipment and strut mounting brackets









TRANSPORTATION









Trasporto · Transport · Transport · Transporte · Transporte · Транспортировка

Cab

CTL 272-18	DESCRIPTION · DESCRIZIONE · BESCHREIBUNG · DESCRIPTION · DESCRIPCIÓN · DESCRIÇÃO · ОПИСАНИЕ	LENGTH · LUNGHEZZA · LÄNGE · LONGUEUR · LONGITUD · COMPRIMENTO · ДЛИНА	WIDTH · LARGHEZZA · BREITE · LARGEUR · ANCHURA · LARGURA · ШИРИНА	HEIGHT · ALTEZZA · HÖHE · HAUTEUR · ALTURA · ALTURA · ВЫСОТА	QUANTITY · QUANTITÀ · MENGE · QUANTITÉ · CANTIDAD · QUANTIDADE · КОЛИЧЕСТВО	WEIGHT · PESO · GEWICHT · POIDS · PESO · PESO · BEC
	CABIN PLATFORM	15' 8"	6' 2"	7' 6"	1	4,409 lb

Upper Part

	QEG ELECTRICAL BOX	9' 8"	5' 7"	6' 10"	1	2,866 lb
	COUNTER JIB	17' 5"	6' 6"	5' 0"	1	9,259 lb
	COUNTER JIB PLATFORM	13' 2"	5' 7"	4' 4"	1	862 lb (cad)
	LUFFING WINCH 45 KW	8' 2"	4' 11"	4' 6"	1	4,762 lb *
	LUFFING WINCH 67 KW	8' 6"	4' 11"	4' 6"	1	5,082 lb *
	HOIST WINCH 67 KW	10' 2"	5' 7"	5' 6"	1	7,716 lb *
	SERVICE DERRICK	8' 2"	2' 10"	8' 0"	1	1,543 lb
	A-FRAME UNIT	22' 12"	8' 2"	39' 8"	1	9,039 lb
	JIB SECTION -1	36' 10"	5' 9"	6' 2"	1	3,307 lb

CTL 272-18	DESCRIPTION · DESCRIZIONE · BESCHREIBUNG · DESCRIPTION · DESCRIPCIÓN · DESCRIÇÃO · ОПИСАНИЕ	LENGTH · LUNGHEZZA · LÄNGE · LONGUEUR · LONGITUD · COMPRIMENTO · ДЛИНА	WIDTH · LARGHEZZA · BREITE · LARGEUR · ANCHURA · LARGURA · ШИРИНА	HEIGHT · ALTEZZA · HÖHE · HAUTEUR · ALTURA · ALTURA · ВЫСОТА	QUANTITY · QUANTITÀ · MENGE · QUANTITÉ · CANTIDAD · QUANTIDADE · КОЛИЧЕСТВО	WEIGHT · PESO · GEWICHT · POIDS · PESO · PESO · BEC
	JIB SECTION -2	34' 5"	5' 11"	6' 1"	1	2,436 lb
	JIB SECTION -3	34' 5"	6' 1"	5' 11"	1	2,072 lb
	JIB SECTION -4	34' 5"	5' 9"	5' 6"	1	2,006 lb
	JIB SECTION -5	17' 4"	5' 9"	6' 1"	1	1,135 lb
	JIB SECTION -6	31' 3"	5' 7"	10' 1"	1	3,307 lb
	2-PART LINE HOIST BLOCK	3' 11"	1' 9"	3' 7"	1	1,221 lb
	4-PART LINE HOIST BLOCK	1' 12"	1' 2"	3' 8"	1	677 lb
	1-PART LINE HOIST BLOCK	1' 5"	1' 5"	4' 4"	1	551 lb

* without rope

** inclusive of ladders, platforms and assembly equipment

TEREX CRANES

Tower Cranes

Via delle Innovazioni, 17
33074 Fontanafredda (PN)
Italy
Ph: +39 0434 989111
Email: info.cranes@terex.com

Rough Terrain Cranes

Via Cassoletta, 76 - Fraz. Crespellano
40053 Valsamoggia (BO)
Italy
Ph: +39 051 6501011
Email: info.cranes@terex.com

August 2019. Product specifications and prices are subject to change without notice or obligation. The photographs and/or drawings in this document are for illustrative purposes only. Refer to the appropriate Operator's Manual for instructions on the proper use of this equipment. Failure to follow the corresponding Operator's Manual when using our equipment or to otherwise act responsibly may result in serious injury or death. The only warranty applicable to our equipment is the standard written warranty applicable to the particular product and sale and Terex makes no other warranty, express or implied. Products and services listed may be trademarks, service marks or trade-names of Terex Corporation and/or its subsidiaries in the USA and other countries. All rights are reserved. Terex, the Terex Crown design and Works For You are trademarks of Terex Corporation or its subsidiaries.

Agosto 2019. Specifiche e prezzi dei prodotti sono soggetti a modifica senza preavviso o altro obbligo. Le fotografie e i disegni in questo documento hanno esclusivamente scopo illustrativo. Consulta il Manuale dell'operatore pertinente per trovare istruzioni per l'utilizzo corretto di questo macchinario. La mancata osservanza delle istruzioni contenute nel relativo Manuale dell'operatore durante l'uso del macchinario e altri comportamenti irresponsabili possono provocare gravi lesioni, anche mortali. L'unica garanzia applicabile ai nostri macchinari è la garanzia scritta standard applicabile al particolare prodotto e alla particolare vendita e Terex è esonerata dal fornire qualsiasi altra garanzia, esplicita o implicita. I prodotti e servizi elencati possono essere dei marchi di fabbrica, marchi di servizio o nomi commerciali di Terex Corporation, e/o delle rispettive società affiliate negli Stati Uniti d'America e in molte altre nazioni. Tutti i diritti riservati. Terex, il marchio Terex Crown e Works for You sono marchi di proprietà di Terex Corporation o delle sue società affiliate.

August 2019. Irrtum und Änderungen der Produktspezifikationen vorbehalten. Die in diesem Dokument enthaltenen Fotos und/oder Zeichnungen dienen rein anschaulichen Zwecken. Für den sachgemäßen Gebrauch der Maschinen ist das entsprechende Bedienerhandbuch heranzuziehen. Unsachgemäßer Umgang mit bzw. unsachgemäßer Einsatz unserer Maschinen kann zu schweren gesundheitlichen Schäden bis hin zum Tod führen. Für unsere Produkte wird ausschließlich die entsprechende, schriftlich niedergelegte Standardgarantie gewährt. Terex leistet keinerlei darüber hinausgehende Garantie, weder ausdrücklich noch stillschweigend. Die genannten Produkte und Dienstleistungen sind in den USA und anderen Ländern ggf. Marken, Dienstleistungsmarken oder Handelsnamen der Terex Corporation und/oder ihrer Tochtergesellschaften. Alle Rechte vorbehalten. Terex, das Terex Kronenlogo und Works For You sind Marken in Eigentum der Terex Corporation bzw. ihrer Tochtergesellschaften.

Août 2019. Les caractéristiques et prix des produits peuvent faire l'objet de modifications sans notification préalable. Les photographies ou dessins présentés dans ce document servent uniquement à des fins d'illustration. Pour connaître les instructions relatives à l'utilisation correcte de cet équipement, veuillez vous référer au manuel de l'utilisateur correspondant. Le non-respect du manuel d'utilisateur correspondant lors de l'utilisation de notre équipement ou des actes irresponsables risquent de provoquer de graves blessures, voire un décès. La seule garantie applicable à nos équipements est la garantie écrite standard applicable au produit et à la vente spécifiques. Terex ne délivre aucune autre garantie, expresse ou implicite. Les produits et les services mentionnés peuvent être des marques, des marques de service ou des appellations commerciales de Terex Corporation et/ou de ses filiales aux États-Unis et dans d'autres pays. Tous droits réservés. Terex, le design Terex Crown et Works For You sont des marques déposées de Terex Corporation ou de ses filiales.

Agosto 2019. Las especificaciones y los precios de los productos están sujetos a cambios sin necesidad de previo aviso ni ninguna otra obligación. Las fotografías y/o dibujos de este documento tienen un fin meramente ilustrativo. Consulte el correspondiente manual de instrucciones del operario para obtener más información sobre el uso correcto de esta maquinaria. No respetar el manual del operario al utilizar la maquinaria o actuar de forma irresponsable puede provocar lesiones graves e incluso mortales. La única garantía aplicable a nuestra maquinaria es la garantía escrita estándar de cada producto y venta. Terex no amplía dicha garantía de forma expresa ni implícita. Los productos y servicios mencionados pueden ser marcas comerciales, marcas de servicio o nombres de marca de Terex Corporation o de alguna de sus filiales en Estados Unidos y otros países. Todos los derechos reservados. Terex, el diseño de la corona Terex y Works For You son marcas registradas de Terex Corporation o de sus filiales.

Agosto 2019. Especificações e preços dos produtos sujeitos a alteração sem aviso prévio ou obrigações. As fotografias e/ou desenhos neste documento são apenas para fins ilustrativos. Consulte o respectivo Manual do Operador para instruções sobre o uso correto deste equipamento. Deixar de acompanhar o respectivo Manual do Operador ao usar o nosso equipamento ou, por qualquer outra forma, deixar de agir de maneira responsável pode resultar em lesões corporais graves ou a morte. A única garantia aplicável ao nosso equipamento é a garantia padrão por escrito correspondente ao produto específico vendido. A Terex não dá outras garantias, expressas ou implícitas. Os produtos e serviços listados podem ser marcas comerciais, marcas de serviço ou nomes-fantasia da Terex Corporation e/ou suas subsidiárias nos EUA e em outros países. Todos os direitos reservados. Terex, o desenho da Coroa Terex e a expressão Works For You são marcas comerciais da Terex Corporation ou suas subsidiárias.

Август 2019 г. года Технические характеристики и цены могут изменяться без предварительного уведомления и без каких-либо обязательств для производителя. Фотографии и (или) чертежи в настоящем документе служат только в качестве иллюстраций. Инструкции по надлежащей эксплуатации данного оборудования см. в соответствующем руководстве для оператора. Невыполнение указаний соответствующих руководств для оператора при эксплуатации оборудования или другие безответственные действия могут повлечь серьезные травмы или смерть. Единственной гарантией, действующей в отношении нашего оборудования, является стандартная форма письменной гарантии на данный тип оборудования и на условия его продажи. Terex не дает никаких других гарантий: ни ясно выраженных, ни подразумеваемых. Перечисленные продукты и услуги могут быть торговыми марками, знаками обслуживания или торговыми наименованиями Terex Corporation и / или ее дочерних компаний в США и других странах. Все права защищены. Terex, изображение короны Terex и Works for You являются торговыми марками, принадлежащими корпорации Terex или ее дочерним компаниям.



www.terex.com/cranes

Brochure Reference: TC-DS-I-E/I/G/F/S/P/R-CTL272-18-08/19



WORKS FOR YOU.™