



T 780
80 US t Lifting Capacity
Truck Crane
Datasheet
Imperial

T 780



Features: T 780

- ▶ 80 US t maximum lifting capacity
- ▶ 126 ft maximum boom length
- ▶ 133 ft maximum tip height
- ▶ Air-ride suspension
- ▶ Travel speeds up to 65 mph

WORKS FOR YOU.™

Key

.....	3
-------	---

Dimensions

Crane dimensions	4, 5, 6
Range diagram	7
Crane weights	8, 9

Load charts

15,000 lb counterweight

Main boom, outriggers fully extended (100%), 360°	9
Main boom, outriggers fully extended (100%), over rear	9
Main boom, 33 ft offsettable jib, 360°	10
Main boom, 57 ft offsettable jib, 360°	10
Main boom, on tires	10

11,000 lb counterweight

Main boom, outriggers fully extended (100%), 360°	11
Main boom, outriggers fully extended (100%), over rear	11
Main boom, 33 ft offsettable jib, 360°	12
Main boom, 57 ft offsettable jib, 360°	12
Main boom, on tires	12

7,000 lb counterweight

Main boom, outriggers fully extended (100%), 360°	13
Main boom, outriggers fully extended (100%), over rear	13
Main boom, 33 ft offsettable jib, 360°	14
Main boom, 57 ft offsettable jib, 360°	14
Main boom, on tires	14

5,000 lb counterweight

Main boom, outriggers fully extended (100%), 360°	15
Main boom, outriggers fully extended (100%), over rear	15
Main boom, 33 ft offsettable jib, 360°	16
Main boom, 57 ft offsettable jib, 360°	16
Main boom, on tires	16

Technical description

Boom	18
Hoist, rope, and hook	18, 19
Cab, controls, operator aids and load limiter / load indicator	19
Superstructure	20
Counterweight	20
Tires	20
Vehicle performance	20
Hydraulic system	20
Carrier, engine, and drive-line	21

	Boom length		General performance
	Tip height		Hoist speed
	Boom with extension		Rope – Standard / Optional
	Telescoping mode		Rope diameter
	Boom angle		Rope length
	Working radius		Max. line pull
	Max. boom length with extension		Electrical system
	Main boom with aux head		Tires
	Hook and block		Engine
	Hook and ball		Steering
	Gradeability		Speed
	Crane / Crane in standard configuration		Slewing / Allowable slewing range
	Gross vehicle weight		Slewing brake
	Weight on front axle		Main hoist
	Weight on rear axle		Auxiliary hoist
	Dolly		Cab
	Counterweight		Operator aids / Load limiter / Load indicator
	Outriggers		Transmission
	Swing/Rotation		Hydraulics
	Over rear		Heating / Air conditioning

CRANE DIMENSIONS

T 780

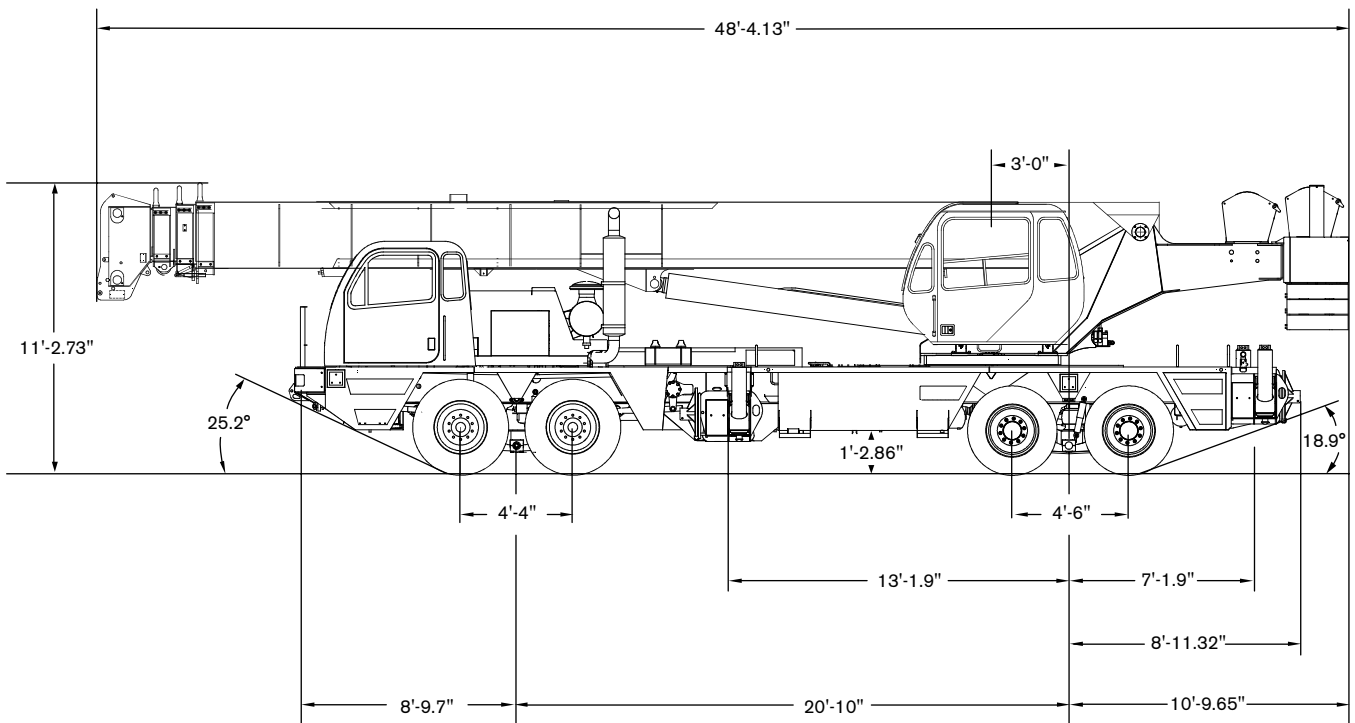

CRANE DIMENSIONS

T 780

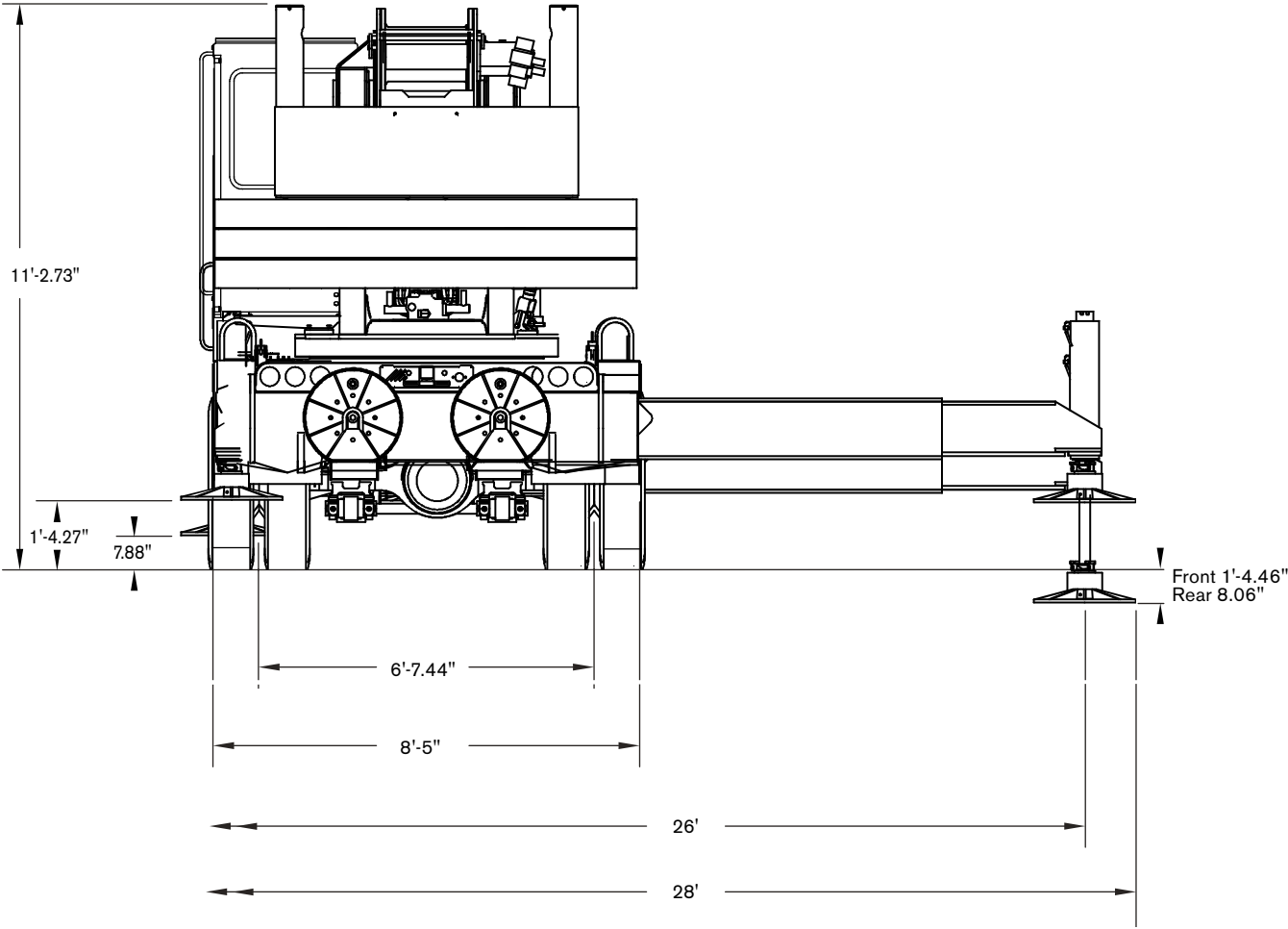

CRANE DIMENSIONS

T 780

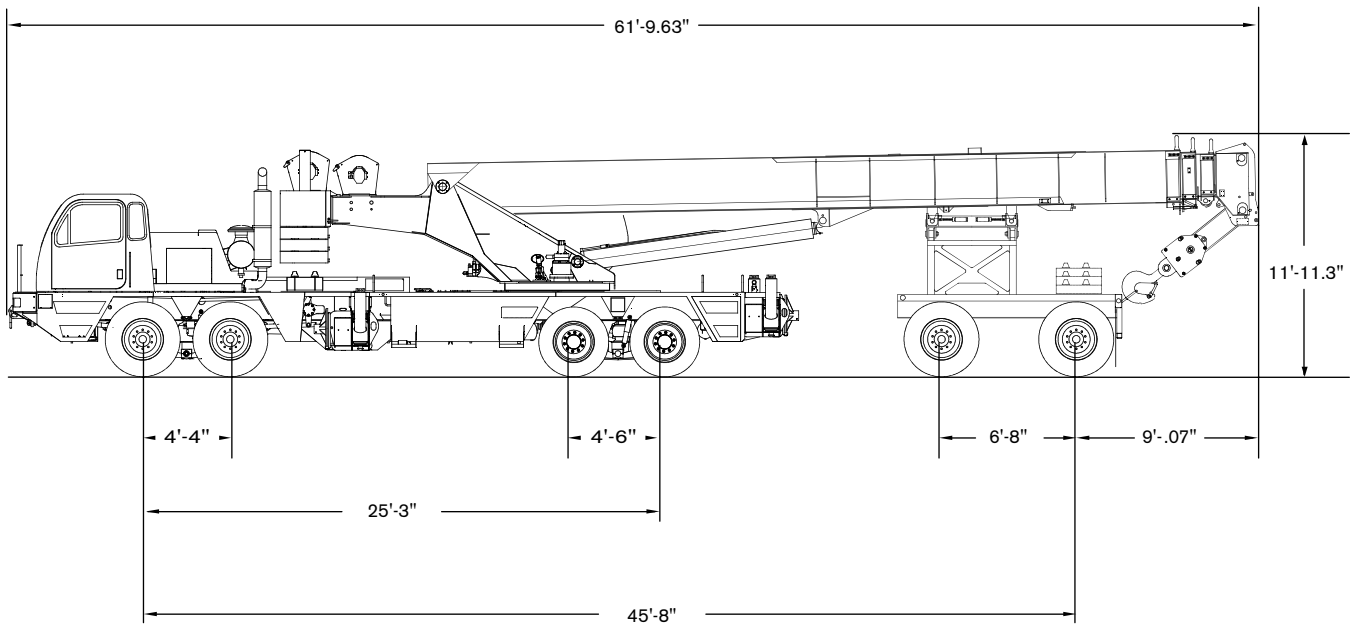

RANGE DIAGRAM - MAIN BOOM

T 780

Outriggers Fully Extended (100%)

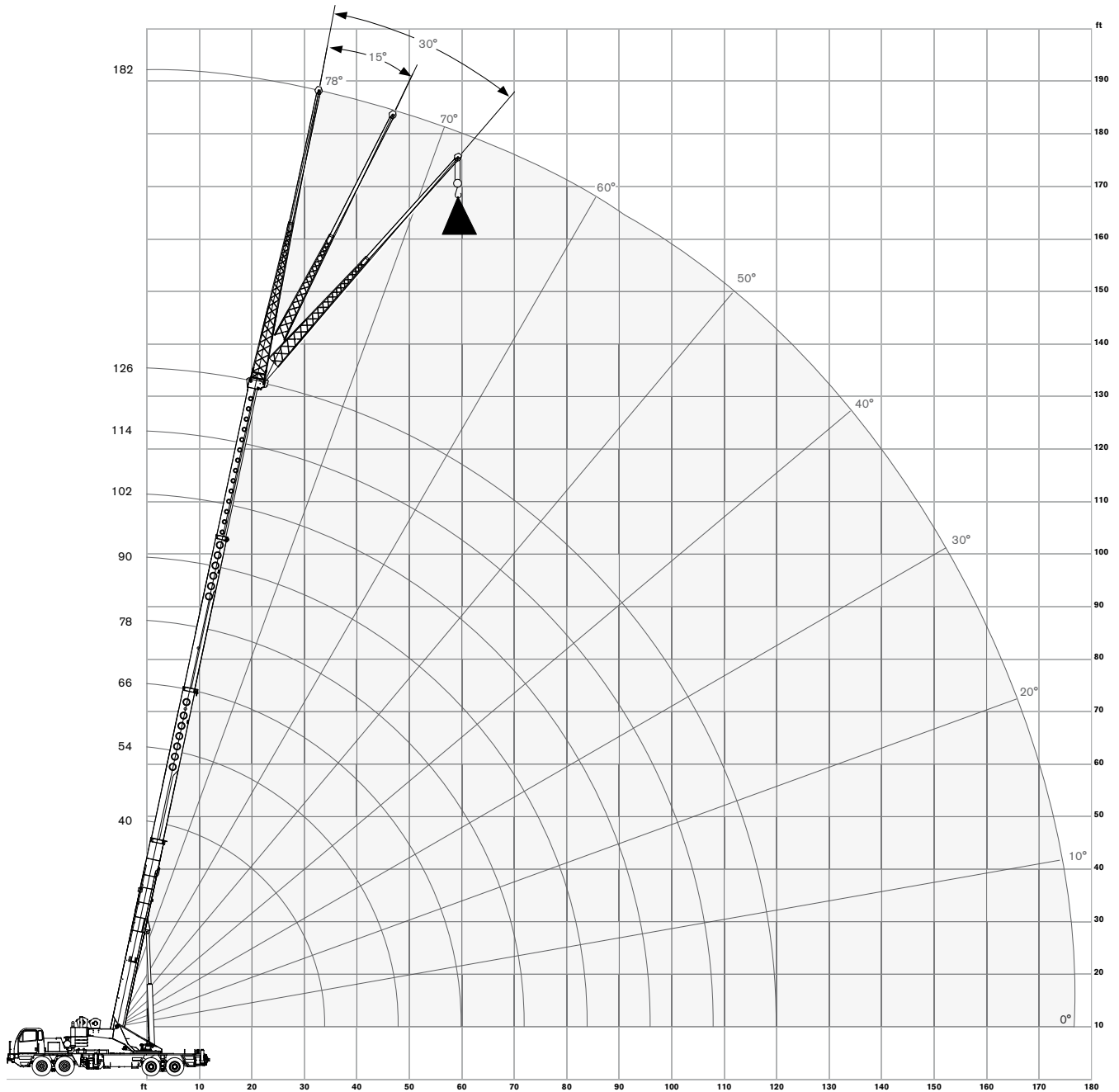

SPECIFICATIONS

T 780



Approximate Crane Weights

Boom in front travel position		 Gross Vehicle	 Front max. 48,000 lb	 Rear max. 60,000 lb
Configuration:	 <p>1/4 tank fuel 200 lb operator seated in cab Front tires: 445/65 20PR Rear tires: 315/80 22.5 20PR 126 ft boom/no jib 2,850 lb rear counterweight and 1,000 lb front bumper counterweight</p>	84,340	39,219	45,121
Add/subtract options				
	2,000 lb counterweight, removable on rear	+ 2,000	- 904	+ 2,904
	4,000 lb counterweight, removable on rear	+ 4,000	- 1,807	+ 5,807
	2,000 lb counterweight, removable on carrier deck	+ 2,000	+ 1,485	+ 515
	4,000 lb counterweight, removable on carrier deck	+ 4,000	+ 2,969	+ 1,031
	Full tank of fuel	+ 547	+ 166	+ 381
	Auxiliary hoist with drum roller and 600 ft of 16 x 9 class wire rope	+ 84	- 31	+ 115
	Spin resistant wire rope – main hoist	+ 96	- 45	+ 141
	Spin resistant wire rope – auxiliary hoist	+ 97	- 55	+ 152
	Electric remote control	+ 200	+ 71	+ 129
	32 ft swing-on jib	+ 1,270	+ 1,208	+ 62
	32 ft to 57 ft extendable swing-on jib	+ 2,174	+ 2,266	- 92
	Auxiliary boom head	+ 125	+ 209	- 84
	80 USt hook block on bumper 5 sheave, quick reeving	+ 1,608	+ 2,569	- 961
	12 USt hook block on bumper	+ 419	+ 669	- 250

SPECIFICATIONS

T 780

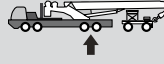
Approximate Crane Weights

Dolly and boom over rear		 Gross Vehicle	 Front max. 48,000 lb	 Rear max. 60,000 lb	 Dolly
Configuration:  1/4 tank fuel 200 lb operator seated in cab Front tires: 445/65 20PR Rear tires: 315/80 22.5 20PR 126 ft boom/no jib 2,850 lb rear counterweight		90,209	31,693	37,902	20,614
Add/subtract options					
	2,000 lb counterweight, removable on rear	+ 2,000	+ 1,485	+ 515	+ 0
	4,000 lb counterweight, removable on rear	+ 4,000	+ 2,970	+ 1,030	+ 0
	2,000 lb counterweight, removable on carrier deck	+ 2,000	+ 1,485	+ 515	+ 0
	4,000 lb counterweight, removable on carrier deck	+ 4,000	+ 2,970	+ 1,030	+ 0
	2,000 lb counterweight, removable on dolly	+ 2,000	+ 0	+ 0	+ 2,000
	4,000 lb counterweight, removable on dolly	+ 4,000	+ 0	+ 0	+ 4,000
	Full tank of fuel	+ 545	+ 244	+ 301	+ 0
	Auxiliary hoist with drum roller and 600 ft of 16 x 9 class wire rope	+ 84	+ 43	+ 41	+ 0
	Spin resistant wire rope – main hoist	+ 96	+ 59	+ 37	+ 0
	Spin resistant wire rope – auxiliary hoist	+ 96	+ 70	+ 26	+ 0
	Electric remote control	+ 200	+ 100	+ 100	+ 0
	32 ft swing-on jib	+ 1,270	+ 13	+ 18	+ 1,239
	32 ft to 57 ft extendable swing-on jib	+ 2,170	+ 62	+ 86	+ 2,022
	Auxiliary boom head	+ 125	- 43	- 60	+ 228
	80 USt hook block on bumper 5 sheave, quick reeving	+ 1,608	- 27	- 37	+ 1,672
	12 USt hook block on bumper	+ 419	- 7	- 10	+ 436

LOAD CHART - MAIN BOOM

T 780

Outriggers Fully Extended (100%)



 15,000 lb

 100%

 360°

 40-126 ft

Standard ASME B30.5

	Boom Length (ft)								
	40	54	66	78	90	102	114	126	
ft	lb	lb	lb	lb	lb	lb	lb	lb	ft
10	160,000	102,500							10
12	125,600	102,500							12
15	108,900	100,500	80,600						15
20	83,800	84,800	71,900	62,200	56,200				20
25	65,500	66,500	64,800	55,700	48,000	41,900			25
30	52,200	53,600	54,000	49,700	41,700	36,400	31,500		30
35		40,900	41,500	41,700	36,600	32,100	29,500	24,700	35
40		32,500	33,100	33,400	32,900	28,600	26,200	24,600	40
45		26,400	27,100	27,400	27,600	25,700	23,500	22,100	45
50			22,500	22,900	23,100	23,300	21,400	20,000	50
55			19,000	19,400	19,700	19,800	19,500	18,200	55
60				16,600	16,800	17,000	17,100	16,600	60
65				14,200	14,500	14,700	14,800	14,900	65
70				12,300	12,600	12,800	12,900	13,000	70
75					11,000	11,100	11,300	11,400	75
80					9,500	9,800	9,900	10,000	80
85						8,500	8,700	8,800	85
90						7,500	7,700	7,700	90
95						6,500	6,700	6,800	95
100							5,800	6,000	100
105							5,000	5,200	105
110								4,500	110
115								3,900	115

Outriggers Fully Extended (100%)



 15,000 lb

 100%

 Over Rear

 40-126 ft

Standard ASME B30.5

	Boom Length (ft)								
	40	54	66	78	90	102	114	126	
ft	lb	lb	lb	lb	lb	lb	lb	lb	ft
10	160,000	102,500							10
12	125,600	102,500							12
15	108,900	100,500	80,600						15
20	84,500	85,300	71,900	62,200	56,200				20
25	65,500	66,500	64,800	55,700	48,000	41,900			25
30	52,200	53,600	54,000	49,700	41,700	36,400	31,500		30
35		40,900	41,500	41,700	36,600	32,100	29,500	24,700	35
40		32,500	33,100	33,400	32,900	28,600	26,200	24,600	40
45		26,400	27,100	27,400	27,600	25,700	23,500	22,100	45
50			22,500	22,900	23,100	23,300	21,400	20,000	50
55			19,000	19,400	19,700	19,800	19,500	18,200	55
60				16,600	16,800	17,000	17,100	16,600	60
65				14,200	14,500	14,700	14,800	14,900	65
70				12,300	12,600	12,800	12,900	13,000	70
75					11,000	11,100	11,300	11,400	75
80					9,500	9,800	9,900	10,000	80
85						8,500	8,700	8,800	85
90						7,500	7,700	7,700	90
95						6,500	6,700	6,800	95
100							5,800	6,000	100
105							5,100	5,200	105
110								4,600	110
115								3,900	115

Notes to lifting capacity

Lifting capacities do not exceed 85% of tipping load. Weight of hook blocks and slings is part of the load, and is to be deducted from the capacity ratings. Consult operation manual for further details.

Note: Data published herein is intended as a guide only and shall not be construed to warrant applicability for lifting purposes. Crane operation is subject to the computer charts and operation manual both supplied with the crane.





LOAD CHART - MAIN BOOM

T 780

With Offset Jibs

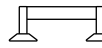
 15,000 lb

 100%

 360°

Standard ASME B30.5

33 ft Offsettable Jib					
0° Offset		15° Offset		30° Offset	
ft	lb	ft	lb	ft	lb
40	12,500	51	8,500	56	6,400
47	12,000	56	8,100	61	6,200
53	11,500	62	7,800	67	6,100
59	10,900	67	7,500	72	5,900
68	9,900	75	7,100	79	5,900
76	9,200	82	6,700	86	5,600
83	8,900	89	6,400	93	5,400
90	7,900	96	6,200	99	5,300
99	6,800	104	5,900	107	5,200
106	5,700	111	5,300	114	5,100
113	4,700	118	4,500	121	4,500
120	3,900	125	3,800	126	3,700
127	3,100	132	3,100	132	3,000
135	2,400	139	2,400	138	2,400
143	1,800	145	1,700		
150	1,300	150	1,300		
152	1,100				

57 ft Offsettable Jib					
0° Offset		15° Offset		30° Offset	
ft	lb	ft	lb	ft	lb
49	6,500	65	4,500	76	3,300
56	6,400	71	4,300	81	3,200
63	6,200	77	4,100	87	3,100
70	6,000	83	3,900	92	3,000
80	5,400	92	3,700	100	2,900
89	4,900	100	3,500	107	2,800
98	4,500	108	3,300	114	2,700
106	4,200	115	3,100	121	2,600
116	3,800	124	2,900	129	2,500
126	3,500	132	2,800	136	2,500
134	3,300	140	2,700	143	2,400
142	3,100	147	2,600	149	2,400
150	2,500	154	2,300	156	2,300
159	1,900	162	1,800	162	1,800
167	1,400	169	1,400		
173	1,000	174	1,000		
177	800				

On Tires

 15,000 lb

 On tires

 Over Rear

Standard ASME B30.5

Boom		Travel Speed: Boom straight over rear		
ft	ft	0 mph	Creep	2.5 mph
		lb	lb	lb
10	40	53,700	38,700	31,200
12	40	49,300	35,300	28,400
15	40	43,800	31,100	24,700
20	40	33,000	25,500	19,900
25	54	23,400	21,100	16,300
30	54	17,700	17,700	13,300
35	54	13,700	13,700	10,900
40	66	11,100	11,100	9,300
45	66	8,900	8,900	7,900
50	66	7,200	7,200	6,700
55	78	5,800	5,800	5,700
60	78	4,600	4,600	4,600
65	78	3,700	3,700	3,700
70	90	3,000	3,000	3,000
75	90	2,400	2,400	2,400
80	90	1,800	1,800	1,800

Notes to lifting capacity

Lifting capacities do not exceed 85% of tipping load, (75% of tipping load on tires). Weight of hook blocks and slings is part of the load, and is to be deducted from the capacity ratings. Consult operation manual for further details.

Note: Data published herein is intended as a guide only and shall not be construed to warrant applicability for lifting purposes. Crane operation is subject to the computer charts and operation manual both supplied with the crane.

LOAD CHART - MAIN BOOM

T 780

Outriggers Fully Extended (100%)

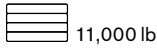

11,000 lb



100%



360°



40-126 ft

Standard ASME
B30.5

ft	Boom Length (ft)								ft
	40	54	66	78	90	102	114	126	
10	160,000	102,500							10
12	125,600	102,500							12
15	108,900	100,500	80,600						15
20	82,000	83,100	71,900	62,200	56,200				20
25	63,400	64,500	64,800	55,700	48,000	41,900			25
30	49,000	50,400	50,800	49,700	41,700	36,400	31,500		30
35		38,400	38,900	39,200	36,600	32,100	29,500	24,700	35
40		30,300	30,900	31,200	31,400	28,600	26,200	24,600	40
45		24,600	25,200	25,600	25,700	25,700	23,500	22,100	45
50			20,900	21,300	21,500	21,600	21,400	20,000	50
55			17,500	17,900	18,100	18,200	18,300	18,200	55
60				15,100	15,400	15,500	15,600	15,700	60
65				12,800	13,100	13,300	13,400	13,400	65
70				11,000	11,300	11,400	11,500	11,600	70
75					9,700	9,900	10,000	10,100	75
80					8,300	8,500	8,700	8,800	80
85						7,400	7,500	7,600	85
90						6,400	6,500	6,600	90
95						5,500	5,600	5,800	95
100							4,900	5,000	100
105							4,100	4,300	105
110								3,600	110
115								3,100	115

Outriggers Fully Extended (100%)

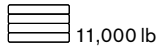

11,000 lb

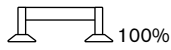

100%



Over Rear



40-126 ft

Standard ASME
B30.5

ft	Boom Length (ft)								ft
	40	54	66	78	90	102	114	126	
10	160,000	102,500							10
12	125,600	102,500							12
15	108,900	100,500	80,600						15
20	82,000	83,100	71,900	62,200	56,200				20
25	63,400	64,500	64,800	55,700	48,000	41,900			25
30	49,000	50,400	50,800	49,700	41,700	36,400	31,500		30
35		38,400	38,900	39,200	36,600	32,100	29,500	24,700	35
40		30,300	30,900	31,200	31,400	28,600	26,200	24,600	40
45		24,600	25,200	25,600	25,700	25,700	23,500	22,100	45
50			20,900	21,300	21,500	21,600	21,400	20,000	50
55			17,500	17,900	18,200	18,300	18,400	18,200	55
60				15,200	15,500	15,700	15,800	15,800	60
65				13,000	13,300	13,500	13,600	13,700	65
70				11,200	11,500	11,700	11,800	11,900	70
75					9,900	10,100	10,200	10,300	75
80					8,600	8,800	8,900	9,000	80
85						7,600	7,800	7,900	85
90						6,600	6,700	6,900	90
95						5,700	5,900	6,000	95
100							5,100	5,200	100
105							4,300	4,500	105
110								3,800	110
115								3,200	115

Notes to lifting capacity

Lifting capacities do not exceed 85% of tipping load. Weight of hook blocks and slings is part of the load, and is to be deducted from the capacity ratings. Consult operation manual for further details.

Note: Data published herein is intended as a guide only and shall not be construed to warrant applicability for lifting purposes. Crane operation is subject to the computer charts and operation manual both supplied with the crane.





LOAD CHART - MAIN BOOM

T 780

With Offset Jibs

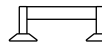
 11,000 lb

 100%

 360°

Standard ASME
B30.5

33 ft Offsettable Jib					
0° Offset		15° Offset		30° Offset	
ft	lb	ft	lb	ft	lb
39	12,500	50	8,500	56	6,400
46	12,000	55	8,100	61	6,200
52	11,500	61	7,800	66	6,100
58	10,900	66	7,500	71	5,900
66	9,900	74	7,100	79	5,900
74	9,200	81	6,700	85	5,600
82	8,600	88	6,400	92	5,400
89	7,500	95	6,200	98	5,300
97	6,200	103	5,600	106	5,200
105	5,000	110	4,700	113	4,500
113	4,100	118	3,900	120	3,700
119	3,300	124	3,200	126	3,100
126	2,500	131	2,400	132	2,400
134	1,800	138	1,800	138	1,700
141	1,200	145	1,200		
148	800	150	800		

57 ft Offsettable Jib					
0° Offset		15° Offset		30° Offset	
ft	lb	ft	lb	ft	lb
48	6,500	64	4,500	75	3,300
56	6,400	70	4,300	80	3,200
63	6,200	76	4,100	86	3,100
70	6,000	82	3,900	91	3,000
80	5,400	91	3,700	99	2,900
89	4,900	99	3,500	106	2,800
98	4,500	107	3,300	113	2,700
106	4,200	114	3,100	120	2,600
116	3,800	123	2,900	128	2,500
125	3,500	132	2,800	135	2,500
133	3,200	139	2,700	142	2,400
141	2,500	146	2,400	148	2,300
149	1,900	154	1,800	155	1,800
157	1,400	162	1,300	161	1,300
165	900	168	800		

On Tires

 11,000 lb

 On tires

 Over Rear

Standard ASME
B30.5

Boom		Travel Speed: Boom straight over rear		
ft	ft	0 mph	Creep	2.5 mph
		lb	lb	lb
10	40	56,000	41,000	33,500
12	40	51,500	37,500	30,500
15	40	45,500	33,000	26,700
20	40	29,500	27,200	21,700
25	54	21,100	21,100	17,800
30	54	16,000	16,000	14,700
35	54	12,600	12,600	12,100
40	66	9,700	9,700	9,700
45	66	7,500	7,500	7,500
50	66	5,900	5,900	5,900
55	78	4,800	4,800	4,800
60	78	4,000	4,000	4,000
65	78	3,300	3,300	3,300
70	90	2,800	2,800	2,800
75	90	2,100	2,100	2,100

Notes to lifting capacity

Lifting capacities do not exceed 85% of tipping load, (75% of tipping load on tires). Weight of hook blocks and slings is part of the load, and is to be deducted from the capacity ratings. Consult operation manual for further details.

Note: Data published herein is intended as a guide only and shall not be construed to warrant applicability for lifting purposes. Crane operation is subject to the computer charts and operation manual both supplied with the crane.

LOAD CHART - MAIN BOOM

T 780

Outriggers Fully Extended (100%)



 7,000 lb

 100%

 360°

 40-126 ft

Standard ASME B30.5

	Boom Length (ft)								
	40	54	66	78	90	102	114	126	
ft	lb	lb	lb	lb	lb	lb	lb	lb	ft
10	149,300	102,500							10
12	125,600	102,500							12
15	106,300	100,500	80,600						15
20	79,600	80,600	71,900	62,200	56,200				20
25	61,500	62,500	63,100	55,700	48,000	41,900			25
30	44,600	46,000	46,400	46,700	41,700	36,400	31,500		30
35		34,900	35,400	35,600	35,800	32,100	29,500	24,700	35
40		27,400	28,000	28,300	28,500	28,600	26,200	24,600	40
45		22,000	22,700	23,000	23,000	23,200	23,400	22,100	45
50			18,700	19,100	19,300	19,400	19,500	19,600	50
55			15,500	15,900	16,100	16,200	16,300	16,400	55
60				13,200	13,500	13,600	13,700	13,800	60
65				11,100	11,400	11,500	11,600	11,700	65
70				9,300	9,600	9,800	9,900	10,000	70
75					8,100	8,300	8,400	8,500	75
80					6,900	7,100	7,200	7,300	80
85						6,000	6,100	6,200	85
90						5,000	5,200	5,300	90
95						4,200	4,400	4,500	95
100							3,600	3,700	100
105							2,900	3,100	105
110								2,500	110
115								2,000	115

Outriggers Fully Extended (100%)



 7,000 lb

 100%

 Over Rear

 40-126 ft

Standard ASME B30.5

	Boom Length (ft)								
	40	54	66	78	90	102	114	126	
ft	lb	lb	lb	lb	lb	lb	lb	lb	ft
10	160,000	102,500							10
12	125,600	102,500							12
15	108,900	100,500	80,600						15
20	79,600	80,600	71,900	62,200	56,200				20
25	61,500	62,500	63,100	55,700	48,000	41,900			25
30	44,600	46,000	46,400	46,700	41,700	36,400	31,500		30
35		34,900	35,400	35,600	35,800	32,100	29,500	24,700	35
40		27,400	28,000	28,300	28,500	28,600	26,200	24,600	40
45		22,000	22,700	23,000	23,000	23,200	23,400	22,100	45
50			18,700	19,100	19,300	19,400	19,500	19,600	50
55			15,500	15,900	16,200	16,300	16,400	16,500	55
60				13,400	13,700	13,900	14,000	14,100	60
65				11,400	11,700	11,900	12,000	12,100	65
70				9,700	10,000	10,200	10,300	10,400	70
75					8,500	8,700	8,900	9,000	75
80					7,300	7,500	7,600	7,800	80
85						6,400	6,600	6,700	85
90						5,500	5,600	5,700	90
95						4,600	4,800	4,900	95
100							4,000	4,200	100
105							3,400	3,500	105
110								2,900	110
115								2,400	115

Notes to lifting capacity

Lifting capacities do not exceed 85% of tipping load. Weight of hook blocks and slings is part of the load, and is to be deducted from the capacity ratings. Consult operation manual for further details.

Note: Data published herein is intended as a guide only and shall not be construed to warrant applicability for lifting purposes. Crane operation is subject to the computer charts and operation manual both supplied with the crane.





LOAD CHART - MAIN BOOM

T 780

With Offset Jibs

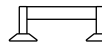
 7,000 lb

 100%

 360°

Standard ASME
B30.5

33 ft Offsettable Jib					
0° Offset		15° Offset		30° Offset	
ft	lb	ft	lb	ft	lb
39	12,500	49	8,500	57	6,400
46	12,000	55	8,100	62	6,200
53	11,500	60	7,800	67	6,100
59	10,900	66	7,500	72	5,900
67	9,900	73	7,100	79	5,900
75	9,200	81	6,700	86	5,600
82	8,000	87	6,400	93	5,400
88	6,800	94	6,000	99	5,300
97	5,400	102	4,900	106	4,500
104	4,200	110	3,900	113	3,600
111	3,300	117	3,100	120	2,900
117	2,600	123	2,400	126	2,200
125	1,800	130	1,600	132	1,600
135	1,200	137	1,000	138	1,100

57 ft Offsettable Jib					
0° Offset		15° Offset		30° Offset	
ft	lb	ft	lb	ft	lb
49	6,500	66	4,500	75	3,300
57	6,400	72	4,300	81	3,200
64	6,200	78	4,100	86	3,100
71	6,000	84	3,900	92	3,000
81	5,400	92	3,700	99	2,900
90	4,900	100	3,500	107	2,800
98	4,500	108	3,300	114	2,700
106	4,200	115	3,100	120	2,600
116	3,800	124	2,900	128	2,500
124	3,200	132	2,800	136	2,500
132	2,400	140	2,200	143	2,200
139	1,800	146	1,700	149	1,700
147	1,200	154	1,200	155	1,200

On Tires

 7,000 lb

 On tires

 Over Rear

Standard ASME
B30.5

Boom		Travel Speed: Boom straight over rear		
ft	ft	0 mph	Creep	2.5 mph
		lb	lb	lb
10	40	55,200	40,300	32,800
12	40	50,800	36,800	29,800
15	40	44,500	32,400	26,100
20	40	27,900	26,600	21,100
25	54	19,400	19,400	17,300
30	54	14,500	14,500	14,200
35	54	11,000	11,000	11,000
40	66	7,900	7,900	7,900
45	66	5,900	5,900	5,900
50	66	4,600	4,600	4,600
55	78	3,800	3,800	3,800
60	78	3,200	3,200	3,200
65	78	2,600	2,600	2,600
70	90	1,800	1,800	1,800

Notes to lifting capacity

Lifting capacities do not exceed 85% of tipping load, (75% of tipping load on tires). Weight of hook blocks and slings is part of the load, and is to be deducted from the capacity ratings. Consult operation manual for further details.

Note: Data published herein is intended as a guide only and shall not be construed to warrant applicability for lifting purposes. Crane operation is subject to the computer charts and operation manual both supplied with the crane.

LOAD CHART - MAIN BOOM

T 780

Outriggers Fully Extended (100%)

 5,000 lb

 100%

 360°

 40-126 ft

Standard ASME B30.5

	Boom Length (ft)								
	40	54	66	78	90	102	114	126	
ft	lb	lb	lb	lb	lb	lb	lb	lb	ft
10	148,200	102,500							10
12	125,600	102,500							12
15	105,300	100,500	80,600						15
20	78,400	79,500	71,900	62,200	56,200				20
25	60,500	61,600	62,100	55,700	48,000	41,900			25
30	42,700	44,100	44,500	44,000	41,700	36,400	31,500		30
35		33,300	33,900	34,100	34,300	32,100	29,500	24,700	35
40		26,100	26,700	27,000	27,200	27,300	26,200	24,600	40
45		21,000	21,600	22,000	22,100	22,300	22,400	22,100	45
50			17,500	17,800	18,000	18,200	18,300	18,300	50
55			14,300	14,700	14,900	15,000	15,100	15,200	55
60				12,200	12,400	12,600	12,700	12,800	60
65				10,200	10,500	10,600	10,700	10,800	65
70				8,500	8,800	8,900	9,000	9,100	70
75					7,400	7,600	7,700	7,800	75
80					6,100	6,400	6,500	6,600	80
85						5,300	5,500	5,600	85
90						4,400	4,600	4,700	90
95						3,600	3,800	3,900	95
100							3,100	3,200	100
105							2,400	2,600	105
110								2,000	110
115								1,500	115

Outriggers Fully Extended (100%)

 5,000 lb

 100%

 Over Rear

 40-126 ft

Standard ASME B30.5

	Boom Length (ft)								
	40	54	66	78	90	102	114	126	
ft	lb	lb	lb	lb	lb	lb	lb	lb	ft
10	160,000	102,500							10
12	125,600	102,500							12
15	108,000	100,500	80,600						15
20	78,400	79,500	71,900	62,200	56,200				20
25	60,500	61,600	62,100	55,700	48,000	41,900			25
30	42,700	44,100	44,500	44,800	41,700	36,400	31,500		30
35		33,300	33,900	34,100	34,300	32,100	29,500	24,700	35
40		26,100	26,700	27,000	27,200	27,300	26,200	24,600	40
45		21,000	21,600	22,000	22,100	22,300	22,400	22,100	45
50			17,700	18,100	18,300	18,500	18,500	18,600	50
55			14,700	15,100	15,400	15,500	15,600	15,700	55
60				12,700	13,000	13,100	13,200	13,300	60
65				10,700	11,000	11,200	11,300	11,400	65
70				9,000	9,300	9,500	9,700	9,800	70
75					7,900	8,100	8,300	8,400	75
80					6,700	6,900	7,100	7,200	80
85						5,900	6,100	6,200	85
90						5,000	5,200	5,300	90
95						4,200	4,300	4,500	95
100							3,600	3,800	100
105							3,000	3,100	105
110								2,500	110
115								2,000	115

Notes to lifting capacity

Lifting capacities do not exceed 85% of tipping load. Weight of hook blocks and slings is part of the load, and is to be deducted from the capacity ratings. Consult operation manual for further details.

Note: Data published herein is intended as a guide only and shall not be construed to warrant applicability for lifting purposes. Crane operation is subject to the computer charts and operation manual both supplied with the crane.





LOAD CHART - MAIN BOOM

T 780

With Offset Jibs

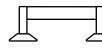
 5,000 lb

 100%

 360°

Standard ASME
B30.5

33 ft Offsettable Jib					
0° Offset		15° Offset		30° Offset	
ft	lb	ft	lb	ft	lb
39	12,500	50	8,500	57	6,400
47	12,000	56	8,100	62	6,200
54	11,500	61	7,800	67	6,100
60	10,900	67	7,500	72	5,900
69	9,900	74	7,100	79	5,900
76	9,200	81	6,700	86	5,600
83	7,600	88	6,400	92	5,400
89	6,300	94	5,600	98	5,200
96	4,800	102	4,400	106	4,200
104	3,700	108	3,500	113	3,300
111	2,800	116	2,700	119	2,500
118	2,200	122	2,000	125	1,900
126	1,500	129	1,300	132	1,300

57 ft Offsettable Jib					
0° Offset		15° Offset		30° Offset	
ft	lb	ft	lb	ft	lb
48	6,500	65	4,500	75	3,300
56	6,400	71	4,300	81	3,200
63	6,200	77	4,100	86	3,100
70	6,000	83	3,900	92	3,000
80	5,400	92	3,700	100	2,900
89	4,900	100	3,500	107	2,800
97	4,500	107	3,300	114	2,700
105	4,200	114	3,100	120	2,600
115	3,600	123	2,900	129	2,500
123	2,800	131	2,500	136	2,400
131	2,100	137	2,000	143	1,800
138	1,600	146	1,400	149	1,400
147	1,000	153	900	155	900

On Tires

 5,000 lb

 On tires

 Over Rear

Standard ASME
B30.5











Boom		Travel Speed: Boom straight over rear		
ft	ft	0 mph	Creep	2.5 mph
		lb	lb	lb
10	40	55,600	40,600	33,200
12	40	49,100	37,200	30,200
15	40	40,000	32,700	26,400
20	40	27,500	26,900	21,400
25	54	18,200	18,200	17,500
30	54	12,400	12,400	12,400
35	54	9,900	9,900	9,900
40	66	7,700	7,700	7,700
45	66	5,600	5,600	5,600
50	66	4,700	4,700	4,700
55	78	3,600	3,600	3,600
60	78	2,700	2,700	2,700
65	78	1,800	1,800	1,800

Notes to lifting capacity

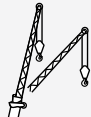
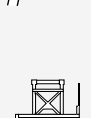



Lifting capacities do not exceed 85% of tipping load, (75% of tipping load on tires). Weight of hook blocks and slings is part of the load, and is to be deducted from the capacity ratings. Consult operation manual for further details.

Note: Data published herein is intended as a guide only and shall not be construed to warrant applicability for lifting purposes. Crane operation is subject to the computer charts and operation manual both supplied with the crane.

Boom



Standard configuration:		
	Full power extension via foot pedal control	4 sections
	Minimum / Maximum	40 ft / 126 ft
	Maximum tip height	133 ft
	Boom elevation angle range (min. / max.)	-4° / 78°
Optional configuration:		
	32 ft swing-on jib, fixed length	
	Angular offsets	0°, 15°, 30°
	Maximum tip height with fixed jib	164 ft
	33–57 ft swing-on jib with 25 ft extension	
	Angular offsets	0°, 15°, 30°
	Maximum tip height with extended jib	189 ft
	Boom Dolly	
	5 or 6 metallic load sheaves	
	2 nylon Idler sheaves	
	Quick reeving design	
	Single nylon sheave	
	Installs only on main boom head, compatible with extendable and fixed swing-on jibs	
	Quick reeving with 5 metal sheaves	80 US t
	Quick reeving with 5 metal sheaves	75 US t
	Quick reeving with 5 metal sheaves	60 US t
	Top swivel ball with hook and latch	12 US t

Hoist and Rope

Standard configuration:		
	Two speed ratios	
	1st layer without load (low range / high range) 5th layer without load (low range / high range)	200 ft/min / 320 ft/min 287 ft/min / 460 ft/min
	Maximum line pull	
	1st layer (low range / high range) 5th layer (low range / high range)	18,450 lb / 10,002 lb 12,845 lb / 6,963 lb
	Permissible line pull	13,800 lb
	6 x 19 IWRC XIPS	
	Rope diameter	3/4 in
		600 ft

Hoist and Rope

Optional configuration - for auxilliary hoist:

	Two speed ratios 1st layer without load (low range / high range) 5th layer without load (low range / high range)	200 ft/min / 320 ft/min 287 ft/min / 460 ft/min
	Maximum line pull 1st layer (low range / high range) 5th layer (low range / high range)	18,450 / 10,002 lb 12,845 / 6,963 lb
	Permissible line pull	13,800 lb
	6 x 19 IWRC XIPS	
	Rope diameter	3/4 in
		600 ft

Optional configuration - for main or auxilliary hoist:

 34 x 7 Grade 960

Cab, Controls, Operator aids and Load limiter / Load indicator

Standard configuration:



Upper cab:

- Sliding door on left side
- Sliding window on the right side
- Tilting, tinted glass skylight
- Removable front windshield
- Six-way adjustable seat with armrest dual-axis electro-proportional joysticks
- Joystick control for hoist(s), swing and boom elevation
- Foot pedals for swing brake, boom telescope and engine rpm
- Hand control for engine rpm

Lower cab:

- Hinged door on left side with roll-down window
- Sliding window on the right side
- Six-way adjustable seat with seatbelt
- Cruise control
- Two speed windshield wiper with washer



Rated capacity indicator with pictograph display of boom radius, boom angle, boom length, allowable load, actual load and % of allowable load

Settable alarms for swing angle, boom length, boom angle, tip height and work area exclusion zone



Optional configuration:



Upper cab:

- Air conditioning – hydraulically powered
- Heater and air conditioning package – hydraulically powered
- Liquid Propane (LP) Cab Heater
- Single-Axis armrest mounted controls
- Work Lights
- Upper cab remote carrier control
- AM/FM radio with cassette

Superstructure

Standard configuration:		
	Foot pedal actuated multi-disc brake and air actuated house lock	360°
	Hydraulic driven double planetary reduction gear drive	2.5 rpm

Counterweight

	Four counterweight packages available	5,000 lb / 7,000 lb / 11,000 lb / 15,000 lb
---	---------------------------------------	---

Tires

Standard configuration:		
	Aluminium wheels with stainless hub covers	
	Front Tires	445 / 65 R22.5
	Rear Tires	315 / 80 R22.5

Vehicle performance

Standard configuration:		
	Theoretical maximum Automatic transmission	100+ %
	Automatic transmission	65 mph

Hydraulic system

Standard configuration:		
	Three-pump system:	
	Tandem pump - Main and auxiliary hoist; boom hoist and telescope	57.3 / 42.6 gal/min @ 4,500 psi
	Single pump - Outriggers and swing	21.2 gal/min @ 3,500 psi
	Single pump - Power steering	8 gal/min @ 1,900 psi
	Simultaneous operation of hydraulic functions	
	Two-speed boom extension	
	Full Flow with bypass protection:	
	Suction	250 micron screen
	Return	5 micron filter
	Pressurized tank with sight level gauge	202 gal

Carrier, Engine and Drive-line

Standard configuration:



Hydraulic assist; Turn radius to centerline of tires

33 ft - 4 in



Axle drive system
Air brakes with ABS, air release / spring set

8 x 4 drive

Front axle – maximum capacity
Tubular beam with equalizer air suspension mounting

48,000 lb

Rear axle – maximum capacity
Interaxle differential with lock-out
Equalizer beam air suspension mounting

60,000 lb



Engine and transmission, EPA 2015 compliant
Detroit Diesel DD13
Intake: Turbocharged and aftercooled
Rated power
Rated torque
Eaton UltraShift Plus fully automated 10-speed transmission
Fuel type
Engine brake

13 L / 450 hp @ 1,800 rpm
1,650 ft-lb @ 1,240 rpm

Ultra low sulfur diesel
Jacobs type

Fuel tank capacity

100 gallon



Voltage
3 Batteries
Alternator

12 VDC
1,000 CCA each
130 amp

Optional configuration:



Engine and transmission, Tier 3. Export only, not for use in U.S. or Canada
Mercedes OM460
Intake: Turbocharged and aftercooled
Rated power
Rated torque
Eaton UltraShift Plus fully automated 10-speed transmission
Fuel type
Engine brake

13 L / 449 hp @ 1,800 rpm
1,475 ft-lb @ 1,300 rpm

Diesel
Exhaust and Jacobs type

Effective Date: September 2015. Product specifications and prices are subject to change without notice or obligation. The photographs and/or drawings in this document are for illustrative purposes only. Refer to the appropriate Operator's Manual for instructions on the proper use of this equipment. Failure to follow the appropriate Operator's Manual when using our equipment or to otherwise act irresponsibly may result in serious injury or death. The only warranty applicable to our equipment is the standard written warranty applicable to the particular product and sale and Terex makes no other warranty, express or implied. Products and services listed may be trademarks, service marks or trade-names of Terex Corporation and/or its subsidiaries in the USA and other countries. All rights are reserved. Terex® is a registered trademark of Terex Corporation in the USA and many other countries. Copyright 2015 Terex Corporation.

Terex Cranes, Global Marketing, Dinglerstraße 24, 66482 Zweibrücken, Germany
Tel. +49 (0) 6332 830, Email: info.cranes@terex.com, www.terexcranes.com



www.terexcranes.com

Brochure Reference: TC-DS-I-E-T780-09/15



WORKS FOR YOU.™