

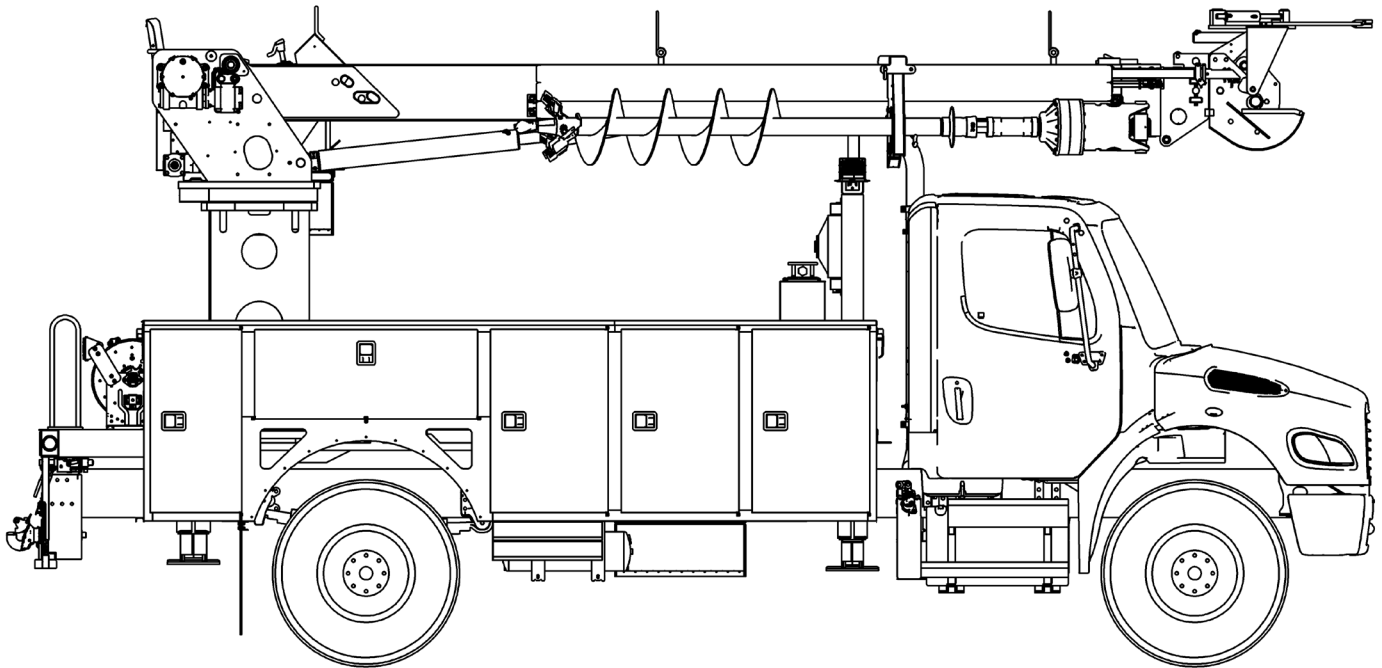

# TECH TIPS

ADJUSTING THE PRESSURE REDUCING VALVE

NO. 08



**SERVICE CALL:**  
ADJUSTING THE PRESSURE  
REDUCING VALVE



**MODEL(S):**  
C3000, C4000, C5000, C6000,  
GENERAL, L4000, XL4000



**TOOLS NEEDED:**  
5/16" ALLEN WRENCH  
0-500 PSI GAUGE

TEREX UTILITIES TECHNICAL SUPPORT TEAM

PHONE: 1-844-TEREX4U (1-844-837-3948) | EMAIL: [UTILITIES.TECHSUPPORT@TEREX.COM](mailto:UTILITIES.TECHSUPPORT@TEREX.COM)

**! WARNING**



**Injection Hazard**  
Fluid escaping under pressure can penetrate skin and result in death or serious injury.

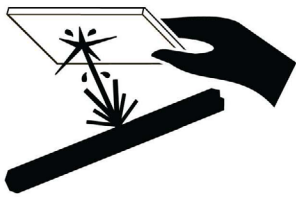

Relieve pressure before disconnecting hydraulic lines.  
Stay clear of leaks and pin holes. Use a piece of cardboard or wood to search for leaks. Do not use hand.  
Fluid injected into skin must be surgically removed within a few hours by a doctor familiar with this type of injury, or gangrene will result.



## DANGER

Failure to obey the instructions and safety rules in the appropriate Operator's Manual and Service Manual for your machine will result in death or serious injury.

Many of the hazards identified in the Operator's Manual are also safety hazards when maintenance and repair procedures are performed.

## DO NOT PERFORM MAINTENANCE UNLESS:

- ✓ You are trained and qualified to perform maintenance on this machine.
- ✓ You read, understand and obey:
  - manufacturer's instructions and safety rules
  - employer's safety rules and worksite regulations
  - applicable governmental regulations
- ✓ You have the appropriate tools, lifting equipment and a suitable workshop.

The information contained in this Tech Tip is a supplement to the Service Manual. Consult the appropriate Service Manual of your machine for safety rules and hazards.



TECH TIP 08 | RELEASED 01.12.2026 | VERSION 1.1  
©TEREX UTILITIES. ALL RIGHTS RESERVED

# CONTENTS

## TECH TIP#08

### TOC

4

| *Install a hydraulic pressure gauge*

**STEP 1 - STEP 2**

5

| *Verify gauge reading*

| *Adjust pressure*

**STEP 3 - STEP 4**

6

| *Adjust pressure*

| *Remove gauge*

**STEP 4 - STEP 5**

## STEP 1

Bring system to normal operating temperature.

## STEP 2

With engine off and the PTO disengaged, locate the return manifold in the pedestal. Identify the "PR" port on the manifold and install a hydraulic pressure gauge.

Note: the gauge should be teed into the circuit.



Escaping fluid under pressure can penetrate skin causing serious injury.

Relieve pressure before disconnecting hydraulic lines. Keep away from leaks and pin holes. Use a piece of cardboard or paper to search for leaks. DO NOT use your hand.

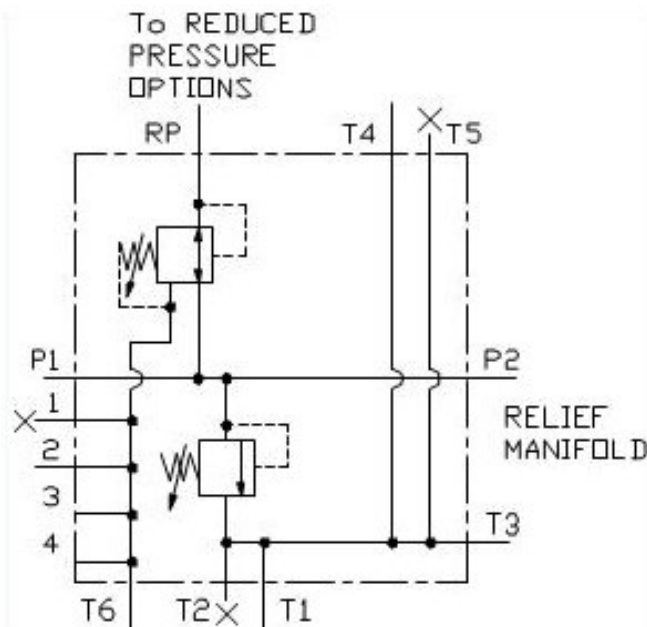

FIGURE 1

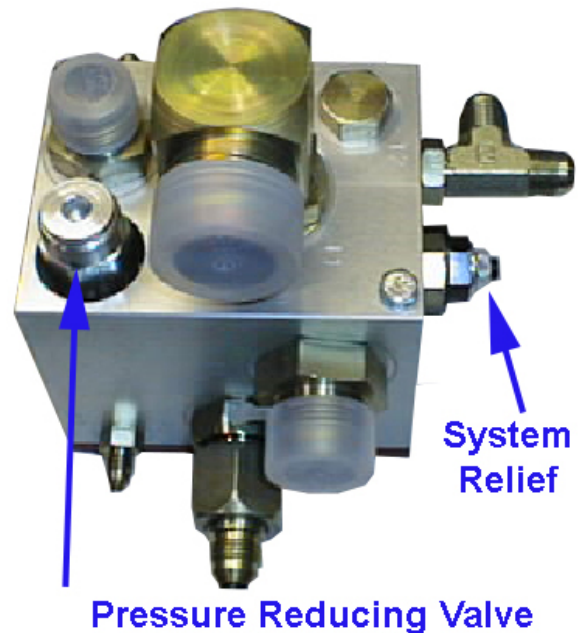

FIGURE 2

Relief manifold with new reduced pressure cartridge (Figure 3).

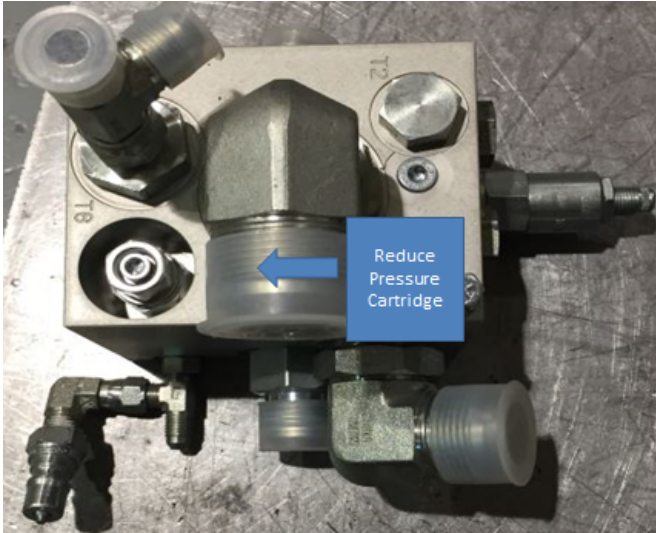

FIGURE 3

Reduced pressure for joystick controls (Figure 4).

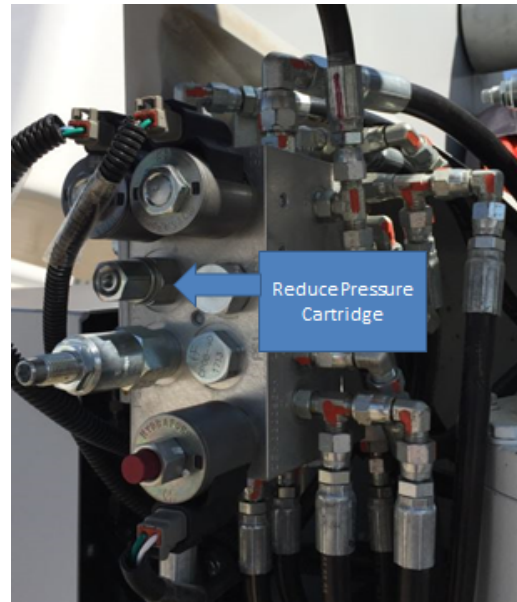

FIGURE 4

### STEP 3

Start the engine, engage PTO, and verify gauge reading.

Typical settings are

- 180 psi on standard units
- 300 psi on units with radio controls or Hydra-Sync digger shift for 2 speed digger

See Quick Reference page in maintenance manual.

### STEP 4

If the reduced pressure requires adjustment, disengage the PTO and return the engine to the off position.

Old style pressure reducing cartridge:

- Remove the cap-plug on top of the pressure reducing valve exposing the adjustment screw inside.
- Turn the adjustment screw clockwise to increase the pressure setting or counterclockwise to reduce the pressure setting.
- Install the cap-plug and retest.

## STEP 4 (Continued)

New style pressure reducing cartridge:

- Insert Allen wrench into Allen head, break jam nut loose and turn clockwise (CW) to increase pressure and counter-clockwise (CCW) to decrease pressure.

Once desired setting is reached, check performance of cartridge by stalling out a boom function (2nd retract) to verify that the valve performs at system pressure. A small increase in reduced pressure may occur during this check but should return to the original setting when 2nd retract is returned to neutral.

## STEP 5

Remove gauge, check for leaks, and verify proper performance of systems that use reduced pressure. (Typical systems are digger shift, auger release, swing away controls or radio controls).



Escaping fluid under pressure can penetrate skin causing serious injury.

Relieve pressure before disconnecting hydraulic lines. Keep away from leaks and pin holes. Use a piece of cardboard or paper to search for leaks. **DO NOT** use your hand.



FOR FURTHER ASSISTANCE,  
CONTACT THE TEREX UTILITIES TECHNICAL SUPPORT TEAM  
PHONE: **1-844-TEREX4U (1-844-837-3948)** | EMAIL: **[UTILITIES.TECHSUPPORT@TEREX.COM](mailto:UTILITIES.TECHSUPPORT@TEREX.COM)**

---