



TECHNICAL
SPECIFICATION

MT130I



OVERVIEW

TECHNICAL SPECIFICATION



SPECIFICATION

Total weight: 62,000 - 67,000kg (136,686 - 147,700lbs)
(Depending on configuration)

Transport: Complete unit dimensions shown.
(Module breakdown for transport shown on pages 16 and 17)

Length: 15.3m (50' 2")
Height: 3.8m (12' 9")
Width: 3.4m (11' 2")

Working:

Length: 16.7m (54' 9")
Height: 3.8m (12' 9")
Width: 3.4m (11' 2")

Crusher type: Impact crusher, feed opening:
1270mm x 925mm (50" x 36"),
Rotor diameter: 1300 (51")

Power unit: Tier 3/Tier 4F/Stage V: CAT C15 430kW
Scania: DC16 450kW

Plant colour: RAL 7030, RAL 3020, RAL 7024, RAL 9005



OVERVIEW

TECHNICAL SPECIFICATION



The MAGNA MT130I impact crusher impresses with high performance, durability, and flexibility. With its powerful crusher and large feed opening, it is ideal for processing a wide range of materials – from natural stone to concrete and demolition waste.

The modular design allows for various drive options: Diesel-Hydraulic, Electro-Hydraulic with Direct Drive, Diesel Hydraulic with Direct Drive, Genset-Hybrid. This provides optimal efficiency and adaptability to different job site requirements. Its robust design and easy operation make it the ideal choice for demanding crushing applications.

FEATURES & BENEFITS

- Output potential up to 600tph / 661 US tph depending on material type crusher settings.
- Diesel-Hydraulic, Electro-Hydraulic with Direct Drive, Diesel Hydraulic with Direct Drive, Genset-Hybrid.
- Modular feed unit allows for flexible hopper extensions.
- Integrated pre-screening systems available in various configurations.
- Powerful impact crusher with large inlet opening for efficient material reduction.
- Underpan feeder as standard.
- Spacious discharge chute under the rotor prevents blockages and simplifies maintenance.
- Wide discharge conveyor (1600mm) provides smooth material flow and high throughput.
- Variable discharge height for efficient integration with downstream equipment.
- Robust construction for long service life under tough working conditions.
- Optional magnetic separator and dust suppression system available.

IMPACT CRUSHER

TECHNICAL SPECIFICATION



- Crusher type:** Twin apron crusher with hydraulic assist setting adjustment
- Feed opening:** 1270mm x 925mm (1100mm) (50" x 36")
- Rotor diameter:** 1300mm (51"), with 4 blow bars
- Speed range:** 450 – 600 rpm
- Lubrication:** Grease (Self-Lubrication)
- Drive:** Hydraulic or electric (250kW)
- Performance:** up to 500tph / 551 US tph
- Drive arrangements:** Hydrostatic or Direct-Drive System via Gearbox

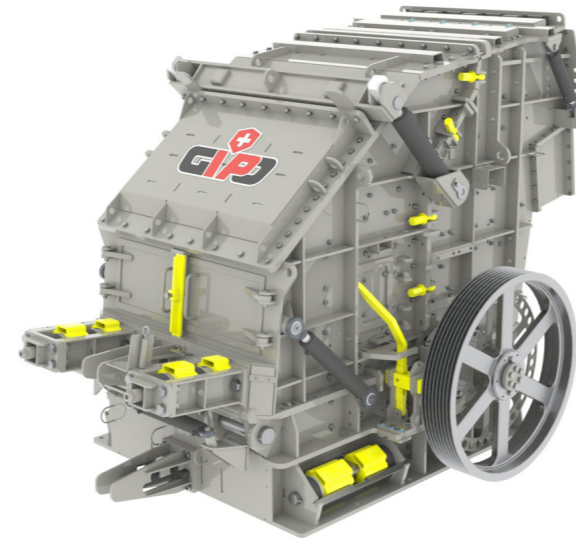

- Side wear plates: 30mm thick, made from Manganese and Hardox steel
- Hydraulic and optional remote adjustment of aprons and grinding path
- Unrestricted feed opening and underpan reduce blockages and bridging, maximising throughput
- Underpan fitted with 25 & 15mm Hardox lining

- Pressure switch for crusher overload control
- Dust suppression fitted at crusher inlet and outlet
- Pin locking system enables quick detachment of crusher hood for transport and maintenance (optional)
- Grinding path (optional)
- Closed rotor, higher inertia (optional)
- Gantry crane for blowbar extraction (optional)

IMPACT CRUSHER

TECHNICAL SPECIFICATION



Primary impact crusher

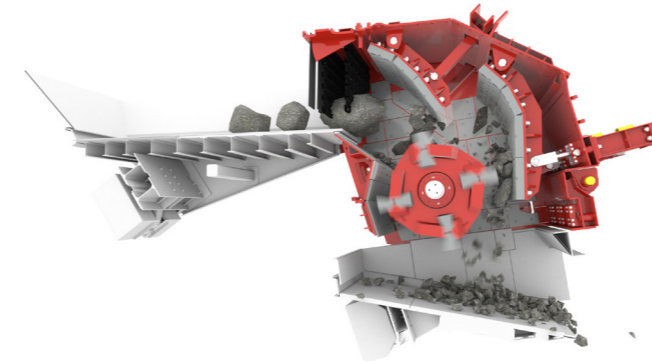

- Pre-crusher for soft and medium-hard rock
- Suitable for large, bulky feed material
- Ability to process steel reinforcing through material flow and reduced interference points

Secondary impact crusher

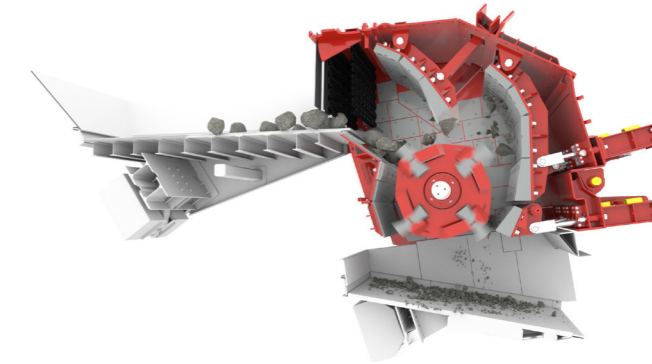

- Pre-crusher and post-crusher for all rock
- Suitable for medium-sized feed material
- Cubic end product with high portion of sand

Third apron, grinding path (optional)

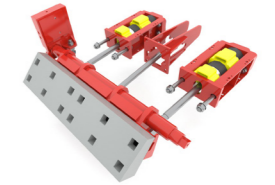

Pin lock system

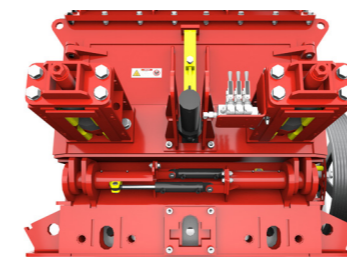

- Quick and easy replacement of the wear parts and weight reduction for fast and efficient transport

Impact bar extracting device / swivelling gantry crane

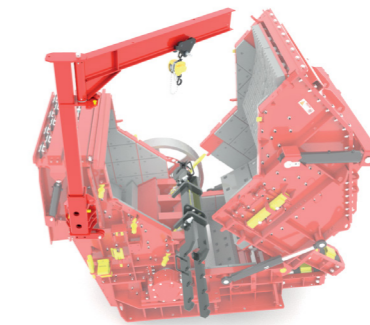

- Reduced downtime and safer maintenance
- Optional crane for simplified replacement of parts

HOPPER

TECHNICAL SPECIFICATION

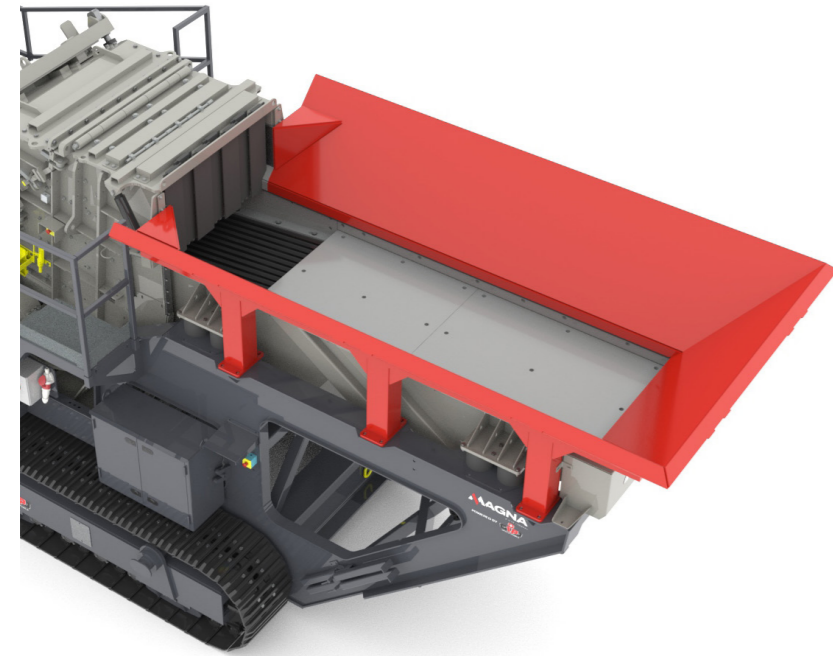

- Hopper type:** Standard fixed or optional hydraulic locking extensions
- Hopper length:** 4.2m - 5.6m (13'9" - 18'5")
- Hopper width:** 2.9m (9'6") standard
3.9m (12'9") with extensions
- Hopper feed heights:** 3.8m - 5.6 (12.5" - 18'5") with extension
- Hopper capacity:** 6m³ - 10m³ (7.9yd³ - 13.1yd³) with extension
- Hopper body:** Abrasion resistant Hardox body.
Screw-in Hardox liners (optional)

Hopper extensions (optional)

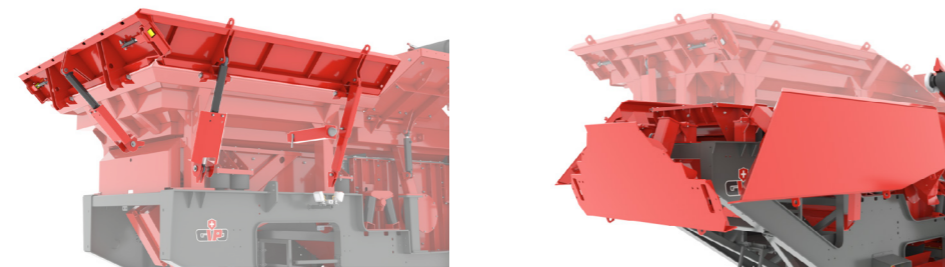

- Standard fixed or Optional hydraulic folding options

PRE-SCREEN UNIT

TECHNICAL SPECIFICATION



MAGNA offers a wide range of feed and pre-screening solutions, tailored to meet all application needs. Various hopper designs and pre-screening units provide optimal material flow and efficient separation-right from the start.

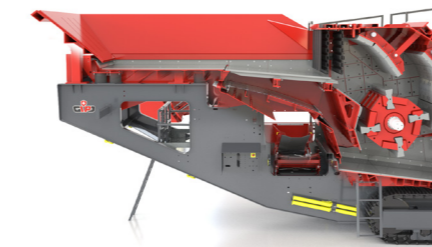

Integrated grizzly section

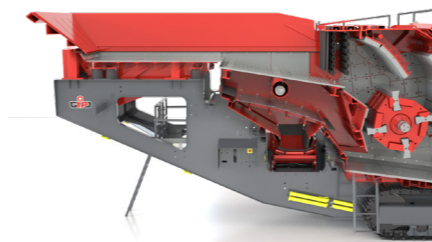

Independent pre-screen

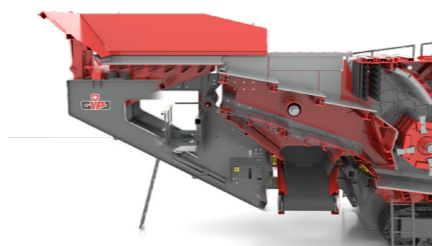

Long independent pre-screen

- Standard pan feeder:** 1.2m x 4.1m (3'11" x 13'6") with integrated VGF
- VGF pan feeder:** 1.2m x 2.4m (3'7" x 7'10") or long version 3.5m (11'6")
- Pre-screen (optional):** Upper deck: 1.2m x 2.3m (3'11" x 7'6") or longer variant 3.2m (10'6")
Lower deck: 1.2m x 1.7m (3'11" x 5'7") or longer variant 2.3m (7'7")
- Media:** Upper deck with either round/slotted punch plate, grizzly bar or stepped punch plate
Blanking covers are available for both decks
- Vibrating unit:** Hydraulic unbalanced drive for the feed chute, eccentric drive system for the pre-screen

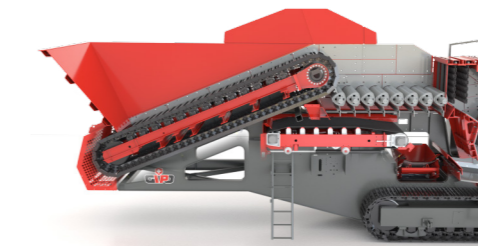

Apron feeder and roller grizzly

8 roller configuration c/w apron feeder and transfer belt

POWER UNIT

TECHNICAL SPECIFICATION



DRIVE TECHNOLOGY

The right drive technology for every application – with proven solutions.

Multiple drive train and power solutions to address every application for highest efficiency and industry requirements.

Power unit: Tier 3/Tier 4F/Stage V:
CAT C15 430kW or C18 571kW,
Scania DC16 450kW or 566kW

Speed range: 1450 - 2100rpm

Crusher drive: 250kW

Fuel tank capacity: 800L - 1100L

Hydraulic tank capacity: 515L - 850L

DRIVE SYSTEMS

TECHNICAL SPECIFICATION



Diesel-hydraulic

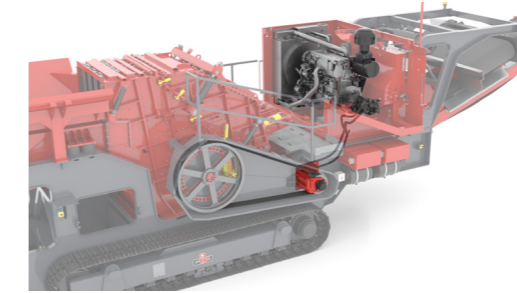

The fully hydraulic drive powers the rotor via a closed-circuit hydraulic motor, delivering with maximum torque and variable speed. Auxiliary drives, including the track unit, operate on a second hydraulic circuit with efficient load sensing and independent speed control.

Diesel-hydraulic with direct drive

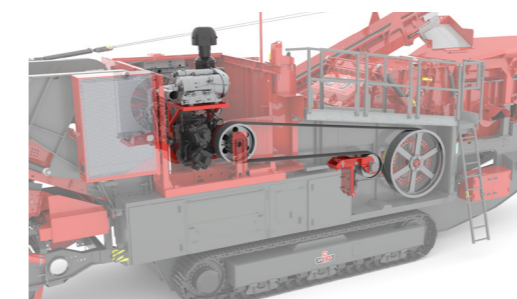

The rotor is driven by a direct mechanical coupling to the diesel engine's flywheel, providing maximum torque transfer. Auxiliary drives, including the track unit, are powered by a speed-optimised hydraulic pump with efficient load sensing, and can be adjusted independently.

Electro-hydraulic with direct drive

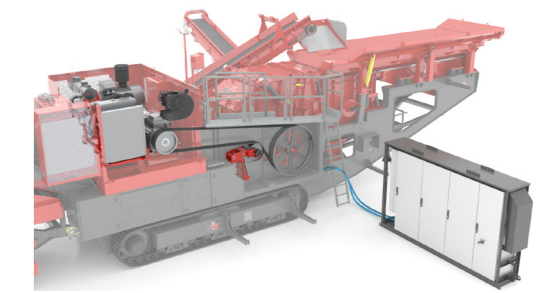

The electric plants are powered via a switch cabinet linked to the motor. The crusher is powered directly by electricity; while auxiliary systems, including the track unit, use a load-sensing hydraulic circuit driven by an electric motor. All drives are continuously and independently adjustable.

GENSET (hybrid)

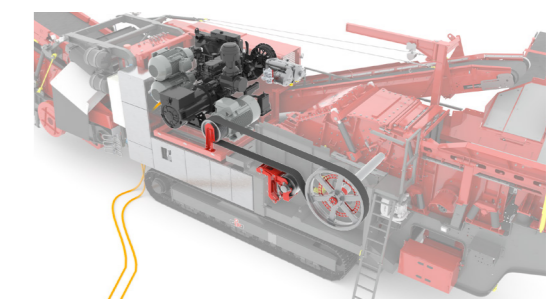

The diesel engine powers a generator that supplies the electric motors for both auxiliary drives and the crusher. Alternatively, the motors can run directly on mains electricity.

CRUSHER DISCHARGE CONVEYOR

Belt width: 1600mm (63")
Belt spec: Plain
Working angle: 27° max
Hydraulically folds for transport (optional)
Discharge height: 3.5m - 5.2m (11'6" - 17'1")
Stockpile capacity: 100m³ (130yds³) @ 40°

PRE-SCREEN SIDE CONVEYOR

Belt width: 650mm - 1000mm (26" - 39")
Belt spec: Plain
Working angle: 25° max
Hydraulically folds for transport (optional)
Discharge height: 3.2m - 4.8m (10'6" - 15'9")
Stockpile capacity: 85m³ (111yds³) @ 40°

ADDITIONAL OPTIONAL EXTRAS

- **Conveyor belts:**
 - Hinged or connector systems for quick transport preparation
 - Variable conveyor belt lengths
 - Hoods and covers
 - Measuring systems and belt scales
 - Magnetic drums
- **Safety and working conditions:**
 - Plant lighting
 - Central lubrication
 - Refuelling pump
 - Water spraying and dust suppression
- **Increased ground clearance**
- **Air compression system**



Magnetic conveyor, longitudinal and cross-discharge

This efficient system enables effective separation of ferrous metals in both directions, which improves recovery, especially in recycling applications. Discharged metals are transported via custom chromium steel slides to a stockpile or container.

Adjustment: Magnet height can be adjusted hydraulically

Belt width: 1.2m x 1.8m (3'11" x 5'11")

Drive: Hydraulic motor and planetary gearbox drive - Heavy duty twin or three pole magnet



Magnetic conveyor, longitudinal discharge with rotating conveyor

Applications include railway sleeper processing, and concrete applications involving high quantities of steel rebar.

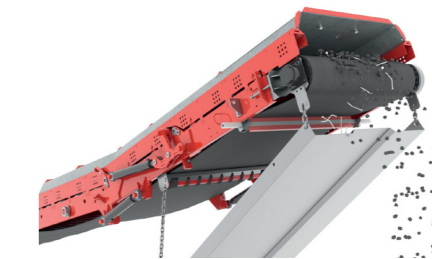

Magnetic drum

Enhances ferrous discharge and separation to improve product quality.

CONTROL SYSTEM

- User friendly incremental selection of feeder and crusher speed enable the operator to achieve optimal throughput
- Detachable doglead control for tracking
- Integrated machine and engine control panel
- Lockable compartment
- Speed regulating feeder selectable for improved throughput control
- Emergency stops
- Umbilical unit supplied as standard
- Controls the tracking function and includes a stop button for the plant

RADIO REMOTE CONTROL

- Full function radio remote unit
- Complete with integrated tracking functions and auto start / stop capabilities

CHASSIS

- Heavy duty I-section welded construction provides maximum strength and accessibility.

GUARDS

- Composite guards are provided for all drives, flywheels, pulleys & couplings
- Designed and manufactured to meet CE & ANSI standards
- Hinged access guards are provided on the top, side and both ends of the engine

PLATFORMS

- Inclined step access on LHS and RHS of machine
- Access steps to rear maintenance platform under feeder
- Full catwalk access to RHS of impact chamber, complete with maintenance platforms
- 2-side access to powerunit
- Full compliance with EN1009 crusher standards

TOOL BOX

- Mounted lockable toolbox
- Tool kit and flogging spanners
- Grease gun
- Manuals

CHUTES

- Heavy-duty inlet chute with bolt-up construction and liner plates

Type:	Heavy-duty tracks, D7	Speed:	2.0kph (1.2mph)
Sprocket centres:	4.7m (15' 5")	Drive:	Hydraulic motors
Track width:	600mm - 700mm (24" - 28")	Tensioning:	Hydraulic adjuster, grease tensioned
Gradeability:	25°		

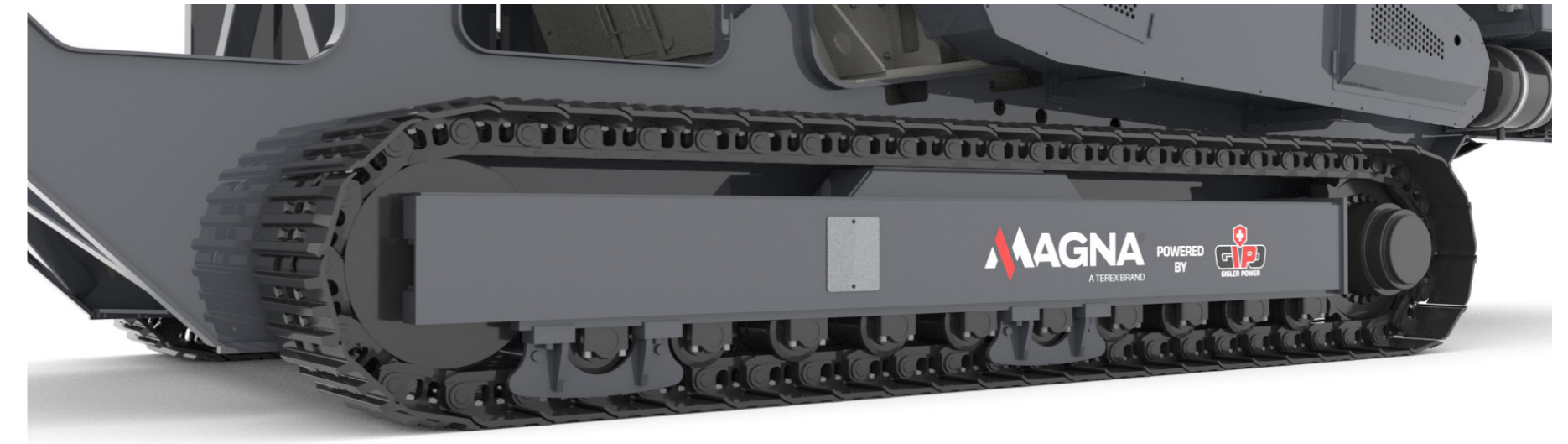

IMPACT CRUSHER PARTS

WEAR PARTS

- High-alloy, high-carbon manganese cast steel – engineered for demanding applications
- Also available with ceramic inserts for enhanced wear resistance

- Side walls lined with highly wear-resistant, individually replaceable high-carbon steel plates
- Choice of impact plate or impact bar design for impact arms

APRON WALLS

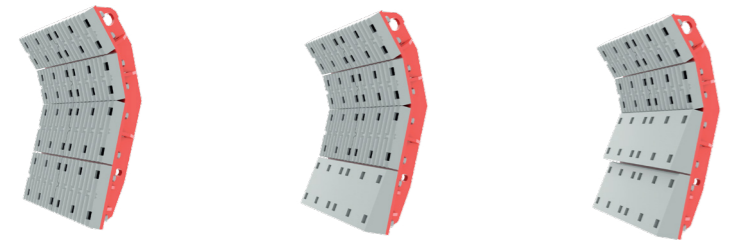

Impact plate design Single impact bar design Double impact bar design

MATERIAL

MANGANESE

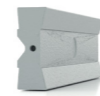

CHARACTERISTICS

- High impact resilience
- Extraordinary capacity for strain
- For low abrasive materials

MARTENSITE CERAMIC

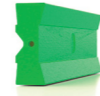

- Consistent wear resistance
- Reduced wear

MARTENSITE CERAMIC PLUS



- Optimised service life (+40% compared to martensite-ceramic)
- Feed material up to 700mm

CHROMIUM



- Extremely wear-resistant
- Feed material size up to 300mm

CLOSED ROTOR

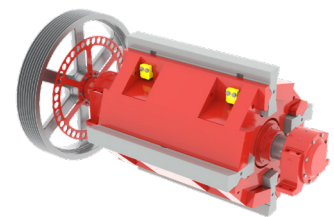

- Reduced volume of oversize product
- Increased inertia for heavy, tough applications

WEIGHT & DIMENSIONS

WORKING

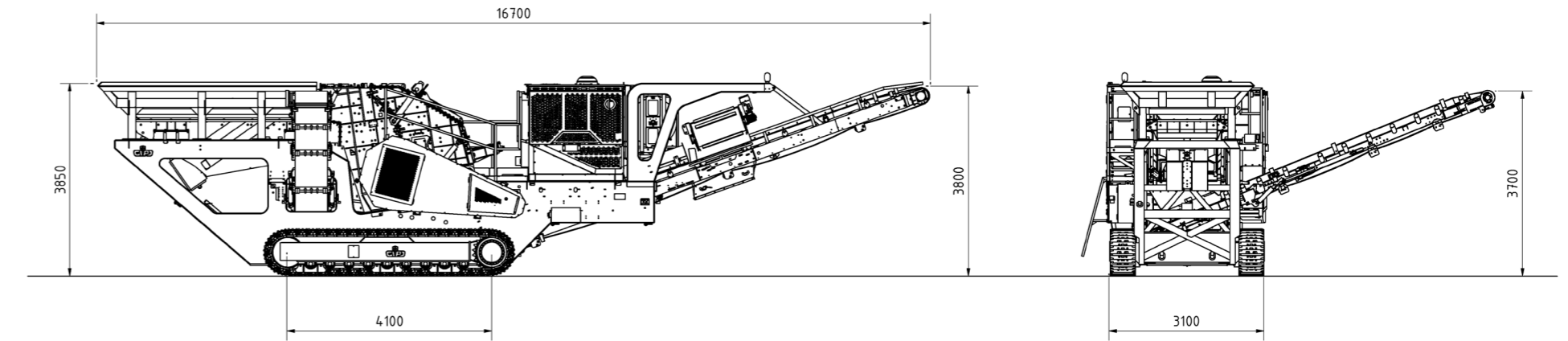

Weight: 62,000 - 67,000kg (136,686 - 147,700lbs)
(Depending on configuration)

All dimensions and weights are approximate and may vary depending on the specific configuration of the plant.



Omagh, UK
Drumquin Road
Omagh
Co. Tyrone
BT78 5PN

Tel: +44 (0) 28 8241 8700
Email: magna@terex.com

terex.com/magna

